



DSEControl



DEEP SEA ELECTRONICS

DSEM835 Operator Manual

Document Number: 057-313

Author: Anthony Manton



Deep Sea Electronics Ltd
Highfield House
Hunmanby
North Yorkshire
YO14 0PH
ENGLAND

Sales Tel: +44 (0) 1723 890099
Sales Fax: +44 (0) 1723 893303

E-mail: sales@deepseaelectronics.com
Website: www.deepseaelectronics.com

DSEM835 Operator Manual

© Deep Sea Electronics Ltd

All rights reserved. No part of this publication may be reproduced in any material form (including photocopying or storing in any medium by electronic means or other) without the written permission of the copyright holder except in accordance with the provisions of the Copyright, Designs and Patents Act 1988.

Applications for the copyright holder's written permission to reproduce any part of this publication must be addressed to Deep Sea Electronics at the address above.

The DSE logo and the name DSEControl® are UK registered trademarks of Deep Sea Electronics Ltd.

Any reference to trademarked product names used within this publication is owned by their respective companies.

Deep Sea Electronics reserves the right to change the contents of this document without prior notice.

Revision History

Issue No.	Comments
1	Initial release of document

TABLE OF CONTENTS

Section	Page
1 INTRODUCTION.....	5
1.1 CLARIFICATION OF NOTATION.....	6
1.2 GLOSSARY OF TERMS.....	6
1.3 RELATED INFORMATION	8
1.3.1 TECHNICAL INFORMATION.....	8
1.4 SAFETY INSTRUCTIONS	9
1.4.1 GENERAL	9
1.4.2 INSTALLATION NOTES	9
2 SPECIFICATIONS	10
2.1 PROCESSOR.....	10
2.2 MEMORY.....	10
2.3 DC SUPPLY	10
2.3.1 FUSING.....	10
2.4 ENVIRONMENTAL	10
2.5 USER INTERFACE	11
2.5.1 CONTROLS.....	11
2.5.2 DISPLAY	11
2.6 INPUTS.....	12
2.6.1 DIGITAL INPUTS	12
2.6.1.1 DIGITAL	12
2.6.2 ANALOGUE INPUTS	12
2.6.2.1 VOLTAGE	12
2.6.2.2 CURRENT.....	13
2.6.2.3 RESISTIVE.....	13
2.7 OUTPUTS.....	13
2.7.1 POSITIVE SWITCHING	13
2.7.2 VREF OUTPUT	13
2.8 COMMUNICATIONS	14
2.8.1 CAN.....	14
3 INSTALLATION	15
3.1 DIMENSIONS AND MOUNTING	15
3.1.1 DIMENSIONS.....	15
3.1.2 PANEL CUTOUT.....	16
3.1.3 WEIGHT	17
3.1.4 FIXING.....	17
3.1.4.1 TORQUE SETTING OF FIXING NUT.....	17
3.2 APPLICABLE STANDARDS	17
3.2.1 ENCLOSURE CLASSIFICATIONS	18
3.2.1.1 IP CLASSIFICATIONS.....	18
3.3 FUSING	19
3.4 USER CONNECTIONS	20
3.5 TYPICAL WIRING DIAGRAM.....	21
3.5.1 EARTH SYSTEMS	22
3.5.1.1 NEGATIVE EARTH	22
3.5.1.2 POSITIVE EARTH	22
3.5.1.3 FLOATING EARTH	22
3.5.2 TYPICAL ARRANGEMENT OF CAN LINK.....	23
4 CONNECTING TO CODESYS.....	24
4.1 INSTALL THE PCAN DRIVER	24
4.2 SETUP THE CODESYS GATEWAY	24
4.2.1 LOCATING WHERE TO STORE THE GATEWAY CONFIGURATION FILE	24
4.3 START NEW PROJECT	26
4.4 CAN CONNECTION.....	27
4.4.1.1 STOPPING AND STARTING THE GATEWAY	28

4.4.2	SCAN NETWORK	29
4.5	DEVICE SETTINGS	30
4.5.1.1	VOLTAGE REFERENCE	30
4.5.1.2	PERSISTANCE SETTINGS	30
4.5.1.3	CAN [1].....	31
4.5.1.4	TRANSPARENCY	31
4.5.2	DEVICE SETTINGS I/O MAPPING.....	32
4.6	ADD INPUTS, OUTPUTS AND BUTTONS TO THE PROJECT	33
4.7	BUTTONS	34
4.7.1	BUTTON LOCATION	34
4.7.2	BUTTON SETTINGS.....	35
4.7.2.1	PARAMETERS	35
4.7.2.2	I/O MAPPING	35
4.8	INPUTS.....	36
4.8.1	DIGITAL INPUTS	37
4.8.1.1	PARAMETERS	37
4.8.2	ANALOGUE INPUTS	37
4.8.2.1	CURRENT.....	37
4.8.2.2	RESISTIVE.....	37
4.8.2.3	VOLTAGE	37
4.9	OUTPUTS.....	38
4.10	USING THE DISPLAY IN THE PROJECT (VISUALISATION)	38
4.10.2	TEXT (FIXED OR DYNAMIC)	39
4.10.2.1	TEXT SIZE	39
4.10.2.2	TEXT COLOUR.....	40
4.10.2.3	STRING ESCAPE CHARACTER \$	41
4.10.2.4	USING FONTS.....	42
4.10.5	ALTERNATIVE TO TEXTLISTS.....	45
4.10.5.1	DYNAMIC TEXT	45
4.10.6	USING CUSTOM IMAGES ON THE DISPLAY	46
4.10.6.1	ADDING AN IMAGE POOL.....	46
4.10.6.2	ADDING IMAGES TO THE IMAGE POOL	46
4.10.6.3	USING THE IMAGE POOL ON THE DISPLAY	48
4.10.6.4	GRAPHICAL GAUGES OR IMAGE SWITCHING	49
4.11	CAN	50
4.11.1	DSE_CAN.....	50
4.11.2	CODESYS J1939	51
5	DSEM835 CODESYS ERROR CODES	54
5.1	DEVICE	54
5.2	DIGITAL INPUTS	54
5.3	DIGITAL OUTPUTS	54
6	CABLES, CONNECTORS, HARNESSSES AND SPARE PARTS.....	55
6.1	DSEM835 CONNECTOR HARNESS (016-176).....	55
6.2	DSEM835 CONFIGURATION HARNESS (016-177)	56
6.3	PCAN-USB CONNECTION DETAILS	56
7	MAINTENANCE AND WARRANTY	57
8	DISPOSAL.....	57
8.1	WEEE (WASTE ELECTRICAL AND ELECTRONIC EQUIPMENT).....	57

1 INTRODUCTION

This document details the operation and setup requirements of the DSEM835 Mobile Controller and Display, part of the DSEControl® range of products.

The manual forms part of the product and should be kept for the entire life of the product. If the product is passed or supplied to another party, ensure that this document is passed to them for reference purposes.

This is not a *controlled document*. DSE do not automatically inform on updates. Any future updates of this document are included on the DSE website at www.deepseaelectronics.com

Observe the operating instructions. Non-observance of the instructions, operation not in accordance with use as prescribed below, wrong installation or incorrect handling seriously affects the safety of operators and machinery.



A robust moulded case designed for fascia (panel) mounting houses the module. Connections are via locking plug and socket.

The controller is supplied with no application program. The equipment manufacturer is responsible for creating and managing the application program and installing it in the controller. This is achieved using CODESYS V3.5 programming. Contact DSE Technical Support for further details.



1.1 CLARIFICATION OF NOTATION

Clarification of notation used within this publication.

 NOTE:	Highlights an essential element of a procedure to ensure correctness.
 CAUTION!	Indicates a procedure or practice, which, if not strictly observed, could result in damage or destruction of equipment.
 WARNING!	Indicates a procedure or practice, which could result in injury to personnel or loss of life if not followed correctly.

1.2 GLOSSARY OF TERMS

Term	Description
Application	The application is the program that allows the DSEM835 to control the machine it is connected to. The Application within the DSEM835 is designed and provided by the manufacturer of the complete machine (OEM).
Bootloader	The Bootloader is the program within the DSEM835 responsible for loading the Operating System.
CAN	Control Area Network. A high-speed data transmission system used extensively within the Automotive and Off-Highway industries.
CODESYS (Previously stylised as CoDeSys)	Integrated Development Environment for programming controller applications according to the international industrial standard IEC 61131-3. DSEM835 supports CODESYS V3.5
DSE	Deep Sea Electronics Ltd. www.deepseaelectronics.com
ECU	Electronic Control Unit. For example, the DSEM835 device.
EMC	Electromagnetic Compatibility. Part of the CE compliance testing for the device and is measure of the level of electromagnetic disturbance the device causes to other nearby electrical devices.
Firmware	The Firmware of the DSEM835 is the Operating System of the DSEM835 that reads and executes the Application program.
FSD	Full Scale Deflection. For example, 0 mA to 20 mA is the Full Scale Deflection of a current sink input.
I/O	Input / Output. For example, "The I/O is taken out to an external terminal strip in the user panel".
IDE	Integrated Development Environment. For example, the CODESYS V3.5 application that runs on the host PC is an IDE.
I _{xyy}	An Input, where x is the connector and yyy is the input number. For example, IA003 means Input 3 on Connector A.
J1939	High Level CAN specification dictated by S.A.E. and used by many Engine ECUs and other CAN devices.
MSeries	Range of CODESYS devices manufactured by Deep Sea Electronics Ltd www.deepseaelectronics.com .
Off-Highway	An industrial vehicle used primarily "off road". For example, construction and farm machinery. A wider interpretation includes on road access platforms, emergency vehicles and other industrial machinery, used either on the road, or off road.
O.E.M.	Original Equipment Manufacturer. The manufacturer of the overall machine that the DSEMSeries device is a part of. The OEM is also responsible for programming the device though they may subcontract this to System Integrators or Programming Houses.

Introduction

Term	Description
PCAN-USB	USB to CAN converter interface for Windows™ PCs. See section entitled <i>Maintenance, Spares, Repair and Servicing</i> elsewhere in this document for part number details.
PLC	Programmable Logic Controller. Industrial computer used primarily for the automation of electromechanical machinery.
Pin	A male or female pin connection in a housing (plug or socket).
Qxyyy	An Output, where x is the connector and yyy is the output number. For example, QA002 means Output 2 on Connector C.
SAE	Society of Automotive Engineers (USA)

1.3 RELATED INFORMATION

This document refers to and is referred by the following DSE publications which are obtained from the DSE website: www.deepseaelectronics.com or by contacting DSE technical support: support@deepseaelectronics.com.

1.3.1 TECHNICAL INFORMATION

DSE Part	Description
055-266	DSEM835 Datasheet
053-250	DSEM835 Installation Instructions
057-270	DSEM240 Operator Manual

1.4 SAFETY INSTRUCTIONS

1.4.1 GENERAL

- These instructions are for authorised persons according to the EMC and low-voltage directives. The device must be installed, connected and put into operation by a qualified electrician.
- It is not permissible to open the controller or to modify or repair the controller. Modification or repairs to the wiring could result in dangerous malfunctions. Repairs to the controller must be performed by DSE. Contact your original equipment supplier in the case of malfunction.
- When the device is unpowered, ensure that no connection pins are connected to a voltage source. Thus, when the supply is switched off, the supply for the electronics, the power outputs and the external sensor supply must be switched off together.
- The customer is responsible for performing risk analysis of the mobile working machine and determining the possible safety related functions. The user is responsible for the safe function of the application programs created. If necessary, they must additionally carry out an approval test by corresponding supervisory and test organisations according to the national regulations.
- All connectors must be unplugged from the electronics during electrical welding and painting operations.

1.4.2 INSTALLATION NOTES

- Follow the instructions of the connector manufacturer, specifically with respect to preventing water from entering the device. See Section entitled *Cables, Connectors, Harnesses and Spare Parts* for details of DSE Part Numbers.
- To maintain IP67 rating where connectors have unused pins, ensure the use of a suitable blanking insert as recommended by the connector manufacturer.

2 SPECIFICATIONS

2.1 PROCESSOR

Description	Specification
Type	STM32h743
Speed	400 MHz

2.2 MEMORY

Description	Specification
Flash	8 MB available for user CODESYS application
RAM	1 MB total 288 kB for application variables.
Non-Volatile FRAM	16 kB for device settings and application persistent variables

2.3 DC SUPPLY

Description	Specification
Operating Voltage (Pin A7)	8 V to 32 V
Maximum Current (Full Backlight, no External Loads)	<80 mA at 24 V <150 mA at 12 V

2.3.1 FUSING

Description	Specification
DC Supply (Pin A7) Supplies DSEM835 and High Current Outputs Fuse as Required by Output Loads (Pins A14, A15, A16)	3 A Min (to supply DSEM835)

2.4 ENVIRONMENTAL

Description	Specification
Operating Temperature	-40 °C to +85 °C (-40 °F to 185 °F)
Storage Temperature	-40 °C to +85 °C (-40 °F to 185 °F)
Degrees of Protection Provided by Enclosure (With All Mating Connectors Fitted)	IP67 (NEMA 6)

2.5 USER INTERFACE

2.5.1 CONTROLS

Description	Specification
Push Buttons	5

2.5.2 DISPLAY

Description	Specification
Size (Across Diagonal)	88.9 mm (3.5")
Size (W x H)	320 px X 240 px
Type	Optically Bonded TFT
Lifetime	> 30,000 hours
Colour	24 bit

2.6 INPUTS

2.6.1 DIGITAL INPUTS

2.6.1.1 DIGITAL

Description	Specification
Applicable Pins	Pins A5, A6, A12, A18
Minimum Voltage For High Level	Configurable
Maximum Voltage For Low Level	Configurable

2.6.2 ANALOGUE INPUTS

2.6.2.1 VOLTAGE

Description	Specification
Applicable Pins	Pins A5, A6, A12, A18
Range	0 V to 10 V
Input Resistance	$\geq 7.5 \text{ k}\Omega$
Sampling Rate	200 Hz

Voltage Measurement resolution and accuracy

Configured Range	Resolution (10 bits)	Accuracy ($\pm 1\%$) FSD
0 V to 10 V	0.003 V	$\pm 0.1 \text{ V}$

2.6.2.2 CURRENT

Description	Specification
Applicable Pins	Pins A5, A6, A12, A18
Configurable Ranges	0 mA to 20 mA 4 mA to 20 mA
Input Type	Current sink only
Input Sink Resistance	150 Ω \pm 1%
Sampling Rate	200 Hz
Resolution	12 bits
Accuracy (\pm 1 % Full Scale Deflection)	0.2 mA

2.6.2.3 RESISTIVE

Description	Specification
Applicable Pins	Pins A5, A6, A12, A18
Measurement Range	0 Ω to 3400 Ω
Measurement Source Voltage	12 V maximum
Measurement Source Current	3 mA
Sampling Rate	200 Hz
Resolution	12 bits
Accuracy (\pm 1 % Full Scale Deflection)	34 Ω

2.7 OUTPUTS

2.7.1 POSITIVE SWITCHING

Description	Specification
Applicable Pins	Pins A14, A15, A16
Maximum Current	1 A
Digital Output Active Low 'ON' State Maximum Voltage at Rated Current	<100 mV
Digital Output Active Low 'OFF' State Leakage Current	<10 μ A at 24 V output supply

2.7.2 VREF OUTPUT

Description	Specification
Applicable Pins	Pin A17
Voltage	5 V / 10 V selectable
Maximum Current	100 mA
Voltage Accuracy	\pm 5 %

2.8 COMMUNICATIONS

2.8.1 CAN

NOTE: Software configurable termination resistor is internally fitted. A complete CAN network must have 120 Ω terminators at each end of the network.

NOTE: Screened 120 Ω impedance cable specified for use with CAN must be used for the CAN links.
DSE stock and supply Belden cable 9841 which is a high quality 120 Ω impedance cable suitable for CAN use (DSE part number 016-030).

Description	Specification
Number of CAN Interfaces	1
Supported Protocols	J1939 Raw CAN
Supported Baud Rates (Factory Setting is 250 kbit/s)	50 kbit/s, 100 kbit/s, 125 kbit/s, 250 kbit/s, 500 kbit/s, 800 kbit/s, 1 Mbit/s
Internal Termination Resistor (Factory Setting is OFF)	Configurable between <i>On</i> and <i>Off</i> using <i>Device Settings</i> from within CODESYS or by user application code using <i>DSE Standard</i> library (namespace DSE).

3 INSTALLATION

3.1 DIMENSIONS AND MOUNTING

3.1.1 DIMENSIONS

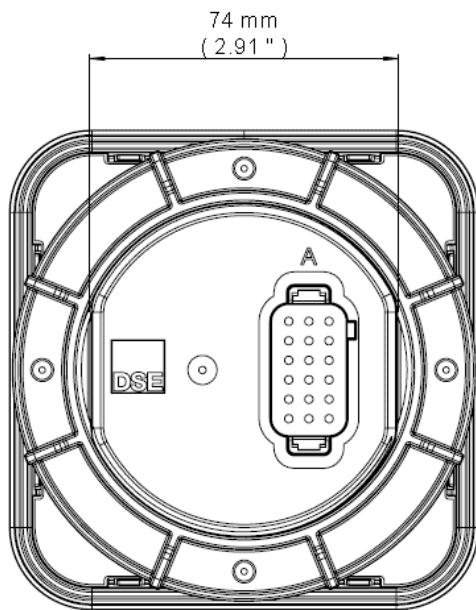
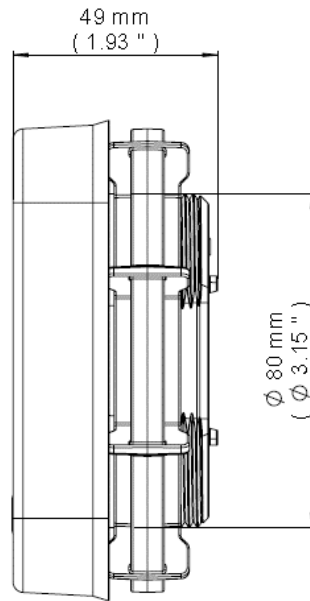
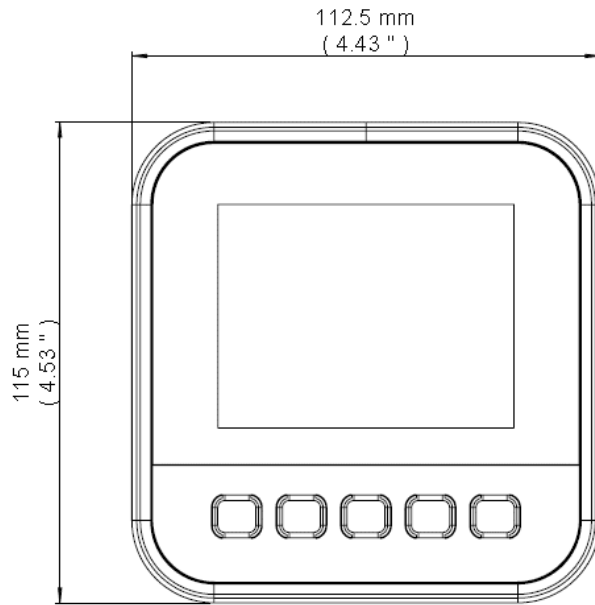

3.1.2 PANEL CUTOUT

82 mm (3.23 ") hole is suitable. Maximum Panel Thickness: 6 mm (0.24 ")

If a punch or milling machine is available, adding 'flats' at 74 mm (2.91 ") spacing serves to prevent rotation of the device in the panel cut-out.

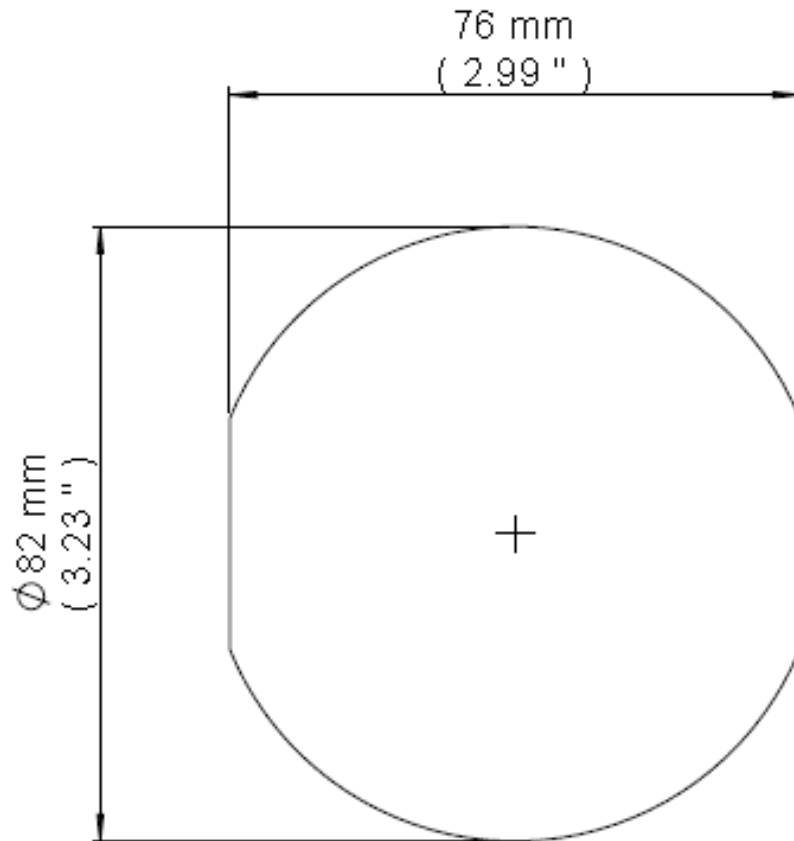

3.1.3 WEIGHT

<1 kg
(<35.3 oz)

3.1.4 FIXING

 **NOTE: In conditions of excessive vibration, mount the housing on suitable anti-vibration mountings.**

The device is held into the panel fascia using the large nut provided.

- Place the controller into the panel aperture.
- Attached the supplied fixing nut and hand tighten to provide adequate fixing (see below).
- Attach the connector plug (Plug A) and push home to click into place.

3.1.4.1 TORQUE SETTING OF FIXING NUT

8 Nm
5.9 ft-lb

3.2 APPLICABLE STANDARDS

Standard	Description
BS EN 60068-2-1 (Minimum temperature)	-40 °C (-40 °F)
BS EN 60068-2-2 (Maximum temperature)	+85 °C (185 °F)
BS EN 61010	Safety requirements for electrical equipment for measurement, control, and laboratory use
BS EN 61000-6-2	EMC Generic Immunity Standard (Industrial)
BS EN 61000-6-4	EMC Generic Emission Standard (Industrial)
BS EN 60529 (Degrees of protection provided by enclosures)	IP67 front and rear

In line with our policy of continual development, Deep Sea Electronics reserve the right to change specification without notice.

3.2.1 ENCLOSURE CLASSIFICATIONS

3.2.1.1 IP CLASSIFICATIONS

 **NOTE: To maintain IP67 rating where connectors have unused pins, ensure the use of a suitable blanking insert as recommended by the connector manufacturer.**

The modules specification under *BS EN 60529 Degrees of protection provided by enclosures* is IP67 as below.

First Digit		Second Digit	
Protection against contact and ingress of solid objects		Protection against ingress of water	
0	No protection	0	No protection
1	Protected against ingress solid objects with a diameter of more than 50 mm. No protection against deliberate access, e.g. with a hand, but large surfaces of the body are prevented from approach.	1	Protection against dripping water falling vertically. No harmful effect must be produced (vertically falling drops).
2	Protected against penetration by solid objects with a diameter of more than 12 mm. Fingers or similar objects prevented from approach.	2	Protection against dripping water falling vertically. There must be no harmful effect when the equipment (enclosure) is tilted at an angle up to 15° from its normal position (drops falling at an angle).
3	Protected against ingress of solid objects with a diameter of more than 2.5 mm. Tools, wires etc. with a thickness of more than 2.5 mm are prevented from approach.	3	Protection against water falling at any angle up to 60° from the vertical. There must be no harmful effect (spray water).
4	Protected against ingress of solid objects with a diameter of more than 1 mm. Tools, wires etc. with a thickness of more than 1 mm are prevented from approach.	4	Protection against water splashed against the equipment (enclosure) from any direction. There must be no harmful effect (splashing water).
5	Protected against harmful dust deposits. Ingress of dust is not totally prevented but the dust must not enter in sufficient quantity to interface with satisfactory operation of the equipment. Complete protection against contact.	5	Protection against water projected from a nozzle against the equipment (enclosure) from any direction. There must be no harmful effect (water jet).
6	Protection against ingress of dust (dust tight). Complete protection against contact.	6	Protection against heavy seas or powerful water jets. Water must not enter the equipment (enclosure) in harmful quantities (splashing over).
		7	No ingress of water in harmful quantity when the enclosure is immersed in water under defined conditions of pressure and time (up to 1 m of submersion)

3.3 FUSING

The individual electric circuits must be protected in order to protect the whole system. Select appropriate fuses to protect the outputs being supplied.

Pin	Description	Comments	Recommended Fuse Size
A7	ECU Supply	Supplies DSEM835 CPU and Outputs	3 A to 10 A Max

3.4 USER CONNECTIONS

NOTE: For suitable connection looms from DSE, see sections entitled *DSEM835 Connector Harness* and *DSEM835 Configuration Harness*.

NOTE: If a prewired connection cable is used, remove the cores with unused signal inputs and outputs. Unused cores, in particular core loops, lead to interference coupling that can influence the connected controller.

NOTE: Screened 120 Ω impedance cable specified for use with CAN must be used for the CAN links.
DSE stock and supply Belden cable 9841 which is a high quality 120 Ω impedance cable suitable for CAN use (DSE part number 016-030).

NOTE: Terminals A11, and A13 are internally connected to A1.

	Pin	Description	Notes
	A1	DC Plant Supply Input (Negative)	Battery negative supply for the device.
	A2	CAN SCR	Connect to Engine ECU CAN SCR
	A3	CAN L (in)	Connect to Engine ECU CAN L
	A4	CAN H (in)	Connect to Engine ECU CAN L
	A5	Input D	Analogue / Digital input D
	A6	Input A	Analogue / Digital input A
	A7	DC Plant Supply input (Positive)	Battery positive supply for the device.
	A8	CAN SCR	Optional to connect to additional CAN devices. Internally connected to A2
	A9	CAN L (out)	Optional to connect to additional CAN devices. Internally connected to A3
	A10	CAN H (out)	Optional to connect to additional CAN devices. Internally connected to A4
	A11	Input Common GND	Provides ground reference to all inputs (A5, A6, A12, A18)
	A12	Input B	Analogue / Digital input B
	A13	VREF Negative	Negative connection for the VREF Output voltage.
	A14	Output A	Max 1 A at the voltage applied to A1
	A15	Output B	Max 1 A at the voltage applied to A1
	A16	Output C	Max 1 A at the voltage applied to A1
	A17	VREF Positive OUT	Positive connection for the VREF Output voltage.
	A18	Input C	Analogue / Digital input C

3.5 TYPICAL WIRING DIAGRAM

NOTE: As systems have differing requirements, these diagrams show only a typical system and do not intend to show a complete system.

NOTE: This diagram shows connection to a Negative Earth system. For Positive Earth and Floating Earth systems, see section entitled *Earth Systems* elsewhere in this document.

NOTE: Screened 120 Ω impedance cable specified for use with CAN must be used for the CAN links.
 DSE stock and supply Belden cable 9841 which is a high quality 120 Ω impedance cable suitable for CAN use (DSE part number 016-030).

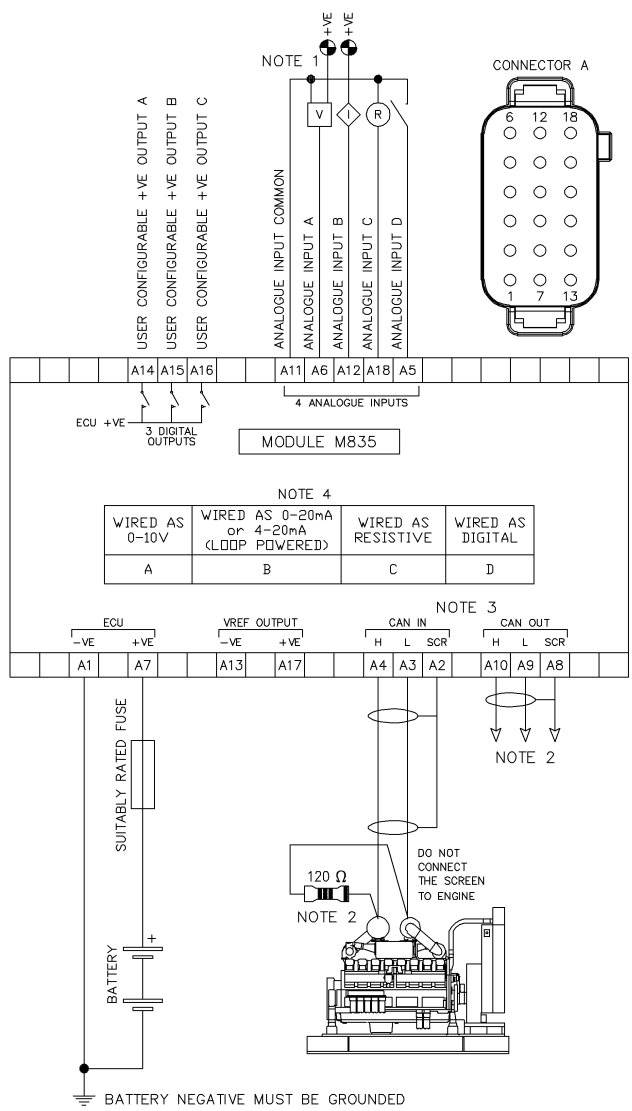

NOTE 1. ANALOGUE INPUT COMMON MUST NOT BE GROUNDED, IT IS LINKED INTERNALLY TO TERMINAL A1.

NOTE 2. 120 Ω TERMINATING RESISTOR MAY BE REQUIRED EXTERNALLY, SEE EXTERNAL EQUIPMENT MANUFACTURERS LITERATURE FOR FURTHER DETAILS.

NOTE 3. CAN IN AND CAN OUT ARE LINKED INTERNALLY.

NOTE 4. ANALOGUE INPUTS CAN BE CONFIGURED AS EITHER A DIGITAL INPUT, RESISTIVE INPUT, 0-10V INPUT, 0-20mA, 4-20mA INPUT, OR ANY COMBINATION OF THE ABOVE.

3.5.1 EARTH SYSTEMS

3.5.1.1 NEGATIVE EARTH

The typical wiring diagrams located within this document show connections for a negative earth system (the battery negative connects to Earth).

3.5.1.2 POSITIVE EARTH

When using a DSE module with a Positive Earth System (the battery positive connects to Earth), the following points must be followed:

Follow the typical wiring diagram as normal for all sections **except** the earth points. All points shown as Earth on the typical wiring diagram should connect to **battery negative** (not earth).

3.5.1.3 FLOATING EARTH

Where neither the battery positive or battery negative terminals are connected to earth the following points must to be followed:

Follow the typical wiring diagram as normal for all sections **except** the earth points. All points shown as Earth on the typical wiring diagram should connect to **battery negative** (not earth).

3.5.2 TYPICAL ARRANGEMENT OF CAN LINK

NOTE: As systems have differing requirements, these diagrams show only a typical system and do not intend to show a complete system.

NOTE: Screened 120 Ω impedance cable specified for use with CAN must be used for the CAN connection.

DSE stock and supply Belden cable 9841 which is a high quality 120 Ω impedance cable suitable for CAN use (DSE part number 016-030)

NOTE: A termination resistor **MUST** be fitted to the first and last unit on the CAN link. An internal 120 Ω termination resistor is fitted. This is configurable within CODESYS Device Settings.

The following image shows a typical connection between the DSEM835 and an engine ECU. Additionally, an *Engine Controller* is included to show how to connect another device on the same CAN. For example, this could be a DSE Genset Controller or a DSEM240 CAN Expansion device providing additional Inputs/Outputs.

While many applications require connection to an engine ECU or other CAN device this is not a requirement for use of the DSEM835 and is included as an example of one typical use only.

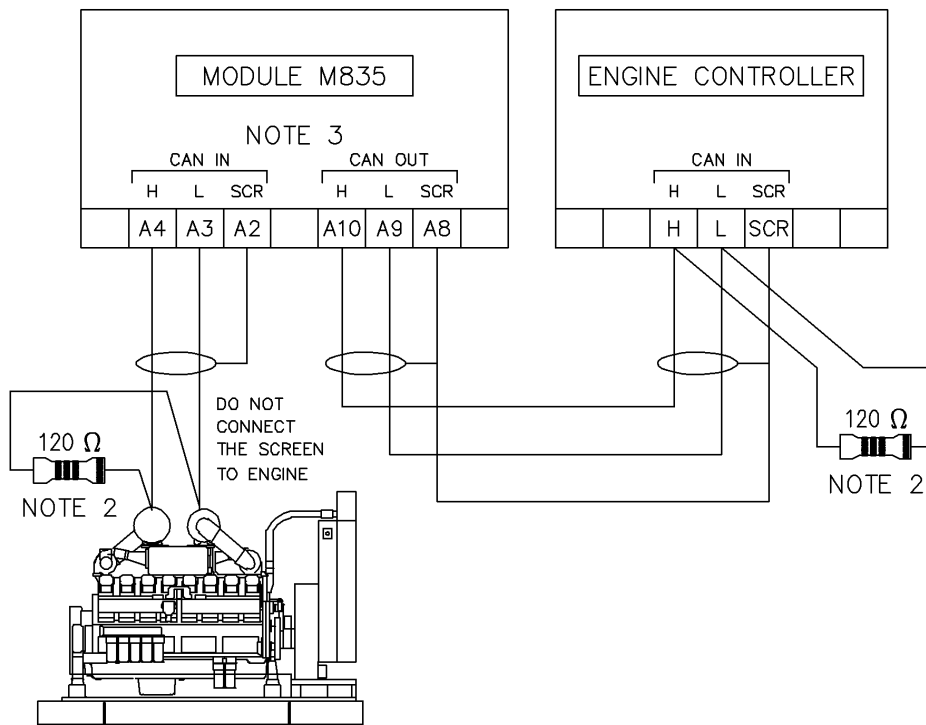

NOTE 2. 120 Ω TERMINATING RESISTOR MAY BE REQUIRED EXTERNALLY, SEE EXTERNAL EQUIPMENT MANUFACTURERS LITERATURE FOR FURTHER DETAILS.

NOTE 3. CAN IN AND CAN OUT ARE LINKED INTERNALLY.

4 CONNECTING TO CODESYS

NOTE: DSEM835 supports CODESYS version 3.5.12.0. Ensure Compiler version, Visualisation version and the versions of any 3S libraries used in the project are no later than version 3.5.12.0. Contact support@deepseaelectronics.com if assistance is required.

NOTE: DSE Stock and supply PCAN-USB IPEH-002021 from Peak Systems (<https://www.peak-system.com>). DSE Part number 016-179. Contact sales@deepseaelectronics.com.

DSEM835 communicates with, and is programmed by, the CODESYS V3.5 Integrated Development Environment (IDE).

To connect the device to a PC, a CAN interface is required as detailed above.

4.1 INSTALL THE PCAN DRIVER

Before proceeding you must install the PCAN Driver supplied with the PCAN Interface, or downloaded from <https://www.peak-system.com/>

4.2 SETUP THE CODESYS GATEWAY

CODESYS Gateway requires configuration to add CAN support. DSE provide the necessary configuration within *Gateway.cfg*, that is available at www.deepseaelectronics.com. This file must be downloaded and used to replace the existing file already in use on the PC where CODESYS is installed. The location of the file varies depending upon your PC setup. Where only one version CODESYS IDE is installed, this is within the *GatewayPLC* folder of that installation. For PCs that have multiple CODESYS IDE versions installed, use the below method to locate the file.

4.2.1 LOCATING WHERE TO STORE THE GATEWAY CONFIGURATION FILE

- In Windows, use search to locate and open the Windows Services application.

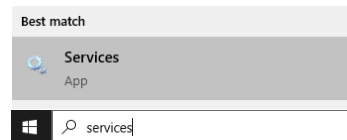

- Click Name (to sort by Name) and then scroll down to locate CODESYS Gateway. The version number shown differs depending upon the last version of CODESYS you installed on the PC

CODESYS Gateway

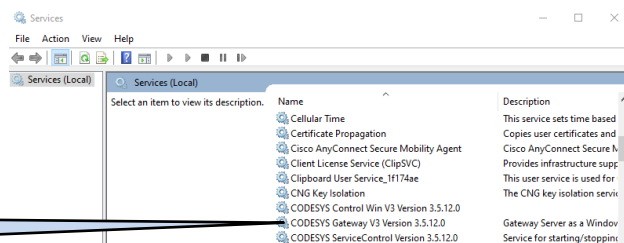

Continued Overleaf...

Connecting to CODESYS

- *Right-Click* the CODESYS Gateway and select *Properties*.
- *Path to executable* shows the location of the GatewayService File.
- Use the mouse to select only the path.
- Ensure to omit the leading “ and omit the trailing *GatewayService.exe*
- *Right-Click* the selection and select *Copy* (or press *CTRL-C*).
- Open *Windows File Explorer* and *Paste* the path just copied.
- This opens *File Explorer* showing the contents.
- Copy the new *Gateway.cfg* file into this folder, overwriting the old one. If you prefer you can take a backup of the old one should you wish to revert to it in future.
- The Gateway must now be stopped and restarted. You can either do this from within *Services*, or you can follow the instructions detailed.

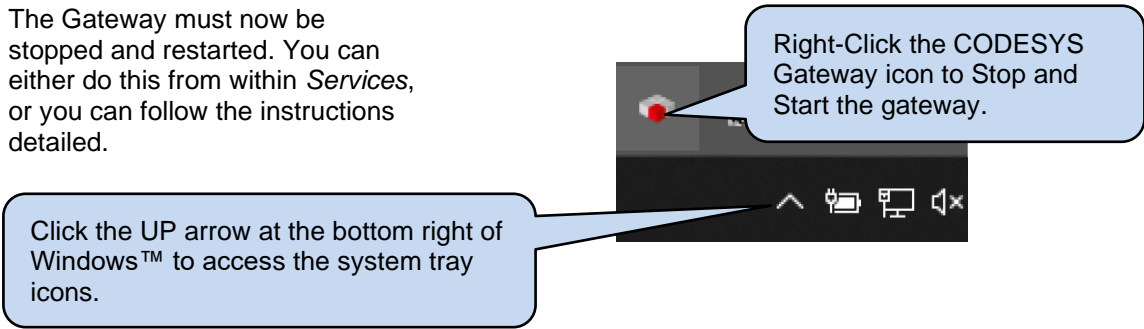
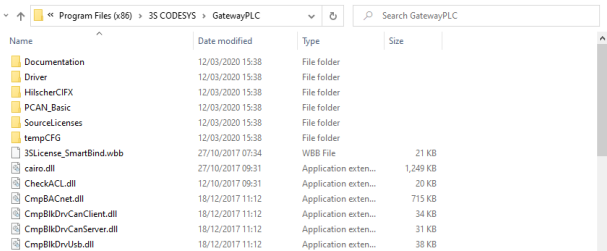
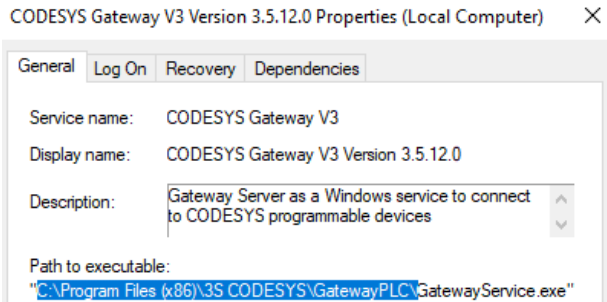

4.3 START NEW PROJECT

To begin, start a new project as shown.

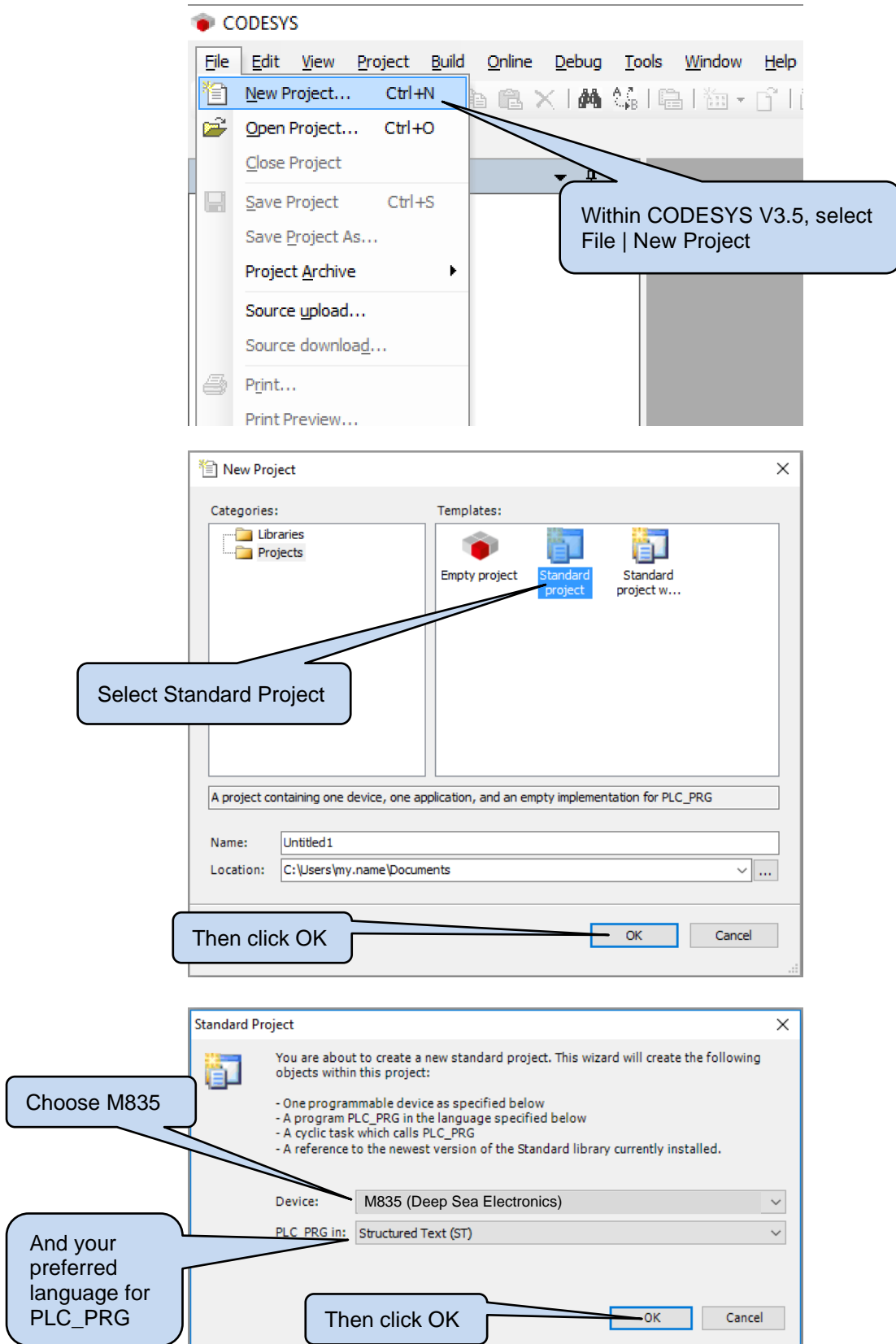

4.4 CAN CONNECTION

NOTE: Ensure previous subsections *Install the PCAN Driver* and *Setup the CODESYS Gateway* have been followed before attempting *CAN Connection*.

NOTE: DSE Stock and supply PCAN-USB IPEH-002021 from Peak Systems (<https://www.peak-system.com>). DSE Part number 016-179. Contact sales@deepseaelectronics.com.

NOTE: Ensure the Gateway is set to operate the CAN port at the same rate that the DSEM835 is set to. Factory Setting is 250 kbit/s though this may have been changed by the OEM or system programmer.

Select *Device | Communication Settings* in the CODESYS V3.5 IDE:

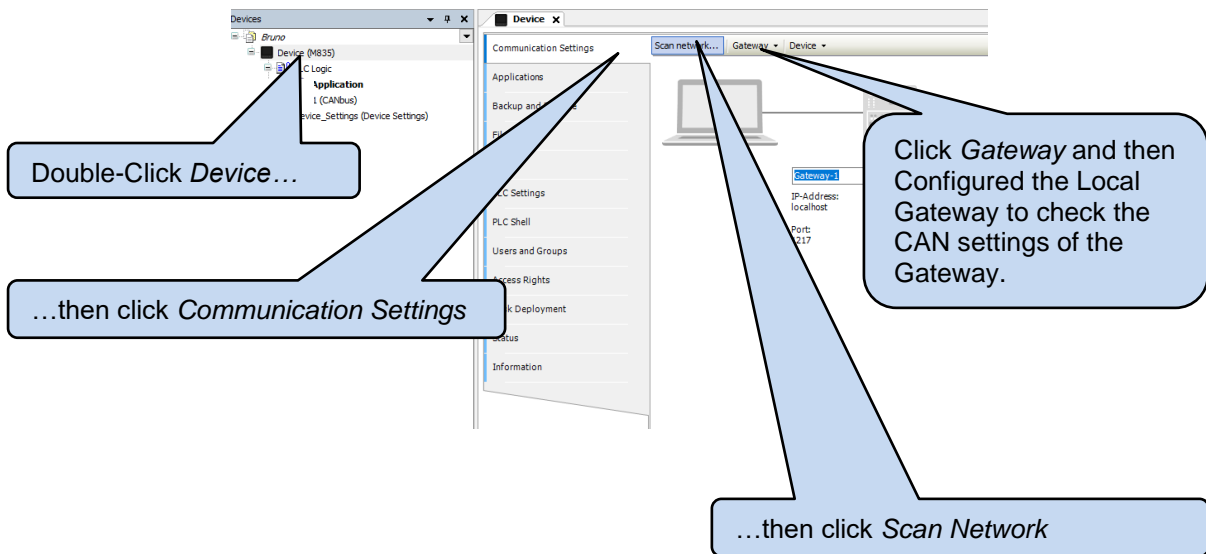

4.4.1 CONFIGURE THE LOCAL GATEWAY

NOTE: If *CAN Client* is not visible within the *Gateway Configuration* then CODESYS is not correctly setup for use with the CAN device. Ensure the latest *DSE CODESYS PACKAGE* is installed. For additional support, contact support@deepseaelectronics.com.

NOTE: Where the baud rate of the device is not known, try all available options. Where no connection is made, use DSEServiceTool PC Software to set the device back to factory settings (250 kbit/s). See DSE Publication 057-265 *DSEServiceTool PC Software Manual* for further details.

NOTE: After changing *Gateway Configuration* settings, the gateway must be stopped and restarted before changes take effect.

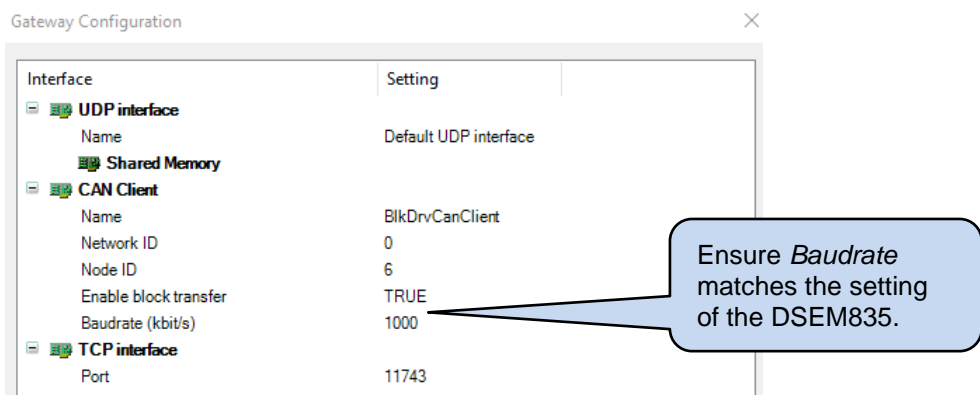

4.4.1.1 STOPPING AND STARTING THE GATEWAY

NOTE: After changing *Gateway Configuration* settings, the gateway must be stopped and restarted before changes take effect.

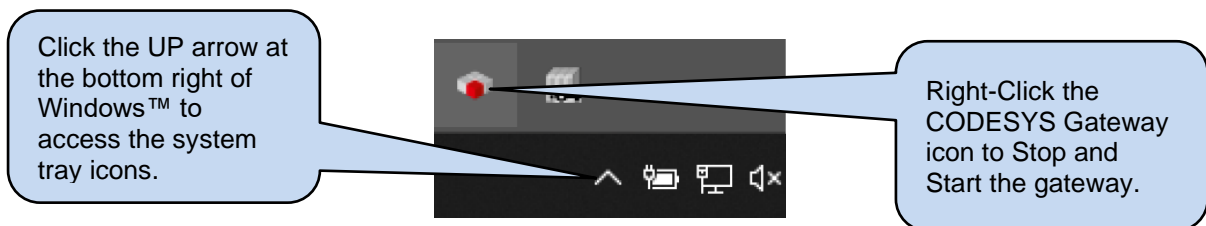

4.4.2 SCAN NETWORK

The image shows a screenshot of the CODESYS software interface. At the top, a 'Select Device' dialog box is open. It has a tree view on the left showing 'Gateway-1' and 'M835-01 [0366.9008]'. A callout bubble points to this tree view with the text 'Devices found on the CAN network.' To the right of the tree view is a list of device details: 'Device Name: M835-01', 'Device Address: 0366.9008', 'Block driver: CAN Server', 'Number of channels: 1', 'Target ID: 1102 0005', 'Target Name: M835-01 (Build 3)', 'Target Type: 4096', 'Target Vendor: Deep Sea Electronics', and 'Target Version: 1.0.0.0'. A callout bubble points to this list with the text 'Details about the selected device.' On the right side of the dialog box, there is a 'Scan network' button and a 'Wink' button. A callout bubble points to the 'Wink' button with the text 'Wink is not supported by DSEM835.' Below the dialog box, the main interface shows a network diagram with a laptop, a 'Gateway' device, and another device. A callout bubble points to the green status icons on the Gateway and the second device with the text 'Successful connection is shown by the green icon.' Below the network diagram, there are two dropdown menus. The first is labeled 'Gateway-1' and the second is labeled '[0366.9008] (active)'. Below these are fields for 'IP-Address: localhost', 'Port: 1217', and a list of device details: 'Device Name: M835-01', 'Device Address: 0366.9008', 'Target ID: 1102 0005', 'Target Type: 4096', 'Target Vendor: Deep Sea Electronics', and 'Target Version: 1.0.0.0'.

4.5 DEVICE SETTINGS

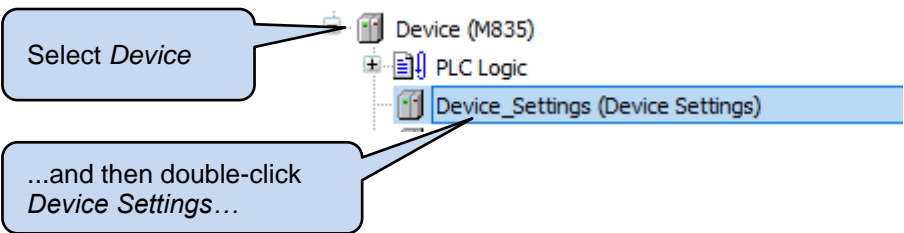

See the following subsections for details of the Device Settings pages.

4.5.1 DEVICE SETTINGS PARAMETERS

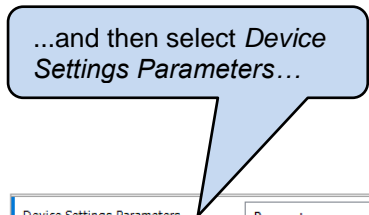

Parameter	Type	Value	Default Value	Unit	Description
Voltage Reference	Enumeration of USINT	Disabled	Disabled		
Persistence Settings					Data Persistence Settings
Active	BOOL	TRUE	0		Activate automatic saving of persistent variables
Time	DWORD	1000	5000	ms	Time in ms for automatic saving of persistent variables
CAN [1]					Configuration of CAN 1
Save Config	Enumeration of USINT	Yes	No		Save Config
ID	USINT	8	8		CAN ID - Must be less than 128
Baudrate	Enumeration of UINT	1000000	500000		Baudrate Value
Terminator Resistor	Enumeration of USINT	Yes	No		Internal 120 Ohm Terminator Resistor
Transparency					Sets the Transparency Color
Active	BOOL	TRUE	0		Activate the Transparency in all images
Colour	DWORD	16#8000FF	8388863	Hex RGB	RGB Colour in Hex

4.5.1.1 VOLTAGE REFERENCE

Parameter	Description
Voltage Reference	<p>Selects the level of the Voltage Reference output. This may be used to supply external sensors or other auxiliary devices.</p> <p>Disabled: Vref is disabled 5V: Output is 5 V DC. 10V: Output is 10 V DC.</p>

4.5.1.2 PERSISTANCE SETTINGS

Parameter	Description
Active	<p>FALSE: Persistent Variables are not saved. TRUE: Persistent Variables are cyclically saved at the period of <i>Time</i>.</p>
Time	<p>Applicable only when <i>Active</i> is set to <i>TRUE</i>. Select the period (milliseconds) of the cyclic saving of Persistent Vars.</p> <p>Minimum Value: 1000 ms. Values below this must not be used. This allows time for the device to write to the Non-Volatile memory block. Recommended Value: 1000 ms to 2000 ms.</p>

4.5.1.3 CAN [1]

Parameter	Description
Save Config	<p>▲ NOTE: After changing CAN settings, the device must be power cycled before changes take effect.</p> <p>No: Changes to the CAN are not applied when the application is sent to the device. Yes: Changes to CAN settings are saved to the device. Powercycle the device after the application is sent to apply the new settings.</p>
ID	ID of the device on the CAN network used during application transfer.
Baudrate	Baudrate of the device on the CAN network used during application transfer and application communication with CAN (ie Engine ECUs and other external devices).
Terminator Resistor	<p>No: Disabled. Yes: Internal 120 Ω termination resistor is enabled on the CAN port.</p>

4.5.1.4 TRANSPARENCY

Parameter	Description
Active	<p>TRUE: Visualisation transparency for images is disabled. FALSE: Visualisation transparency for images is enabled.</p>
Colour	Enter the RGB value of the colour to be used as the transparent part of images in the Visualisation.

4.5.2 DEVICE SETTINGS I/O MAPPING

Allows mapping of the following parameters to program variables,

Parameter	Description
Error Code	Displays internal Error Code when available. For details, see section entitled <i>DSEM835 CODESYS Error Codes</i> .
Battery Voltage	ECU supply of the DSEM835 device.
Voltage Reference	Configuration of the Vref voltage output.
Backlight	Configuration of the LCD backlight.
Keyboard Backlight	Configuration of the backlight of the fascia button surround.

4.6 ADD INPUTS, OUTPUTS AND BUTTONS TO THE PROJECT

NOTE: Many programmers prefer to use the Inputs, Outputs and Buttons programmatically (using code). This is achieved using the library *DSE Standard* (Namespace: DSE). Additionally, *M835_Buttons* function is available within the library *DSE Utils* (Namespace: DSE_UTILS. Both libraries are available within the *DSE CODESYS Package* from www.deepseaelectronics.com.

The image shows two screenshots from the CODESYS software interface. The top screenshot shows the 'Devices' tree with a right-click context menu open over a 'Device (M835)' object. The 'Add Device...' option is highlighted. The bottom screenshot shows the 'Add Device' dialog box with 'Deep Sea Electronics' selected in the search field. A table lists available devices:

Name	Vendor	Version	Description
M835 Buttons	Deep Sea Electronics	1.0.0.0	M835 Buttons
M835 Inputs	Deep Sea Electronics	1.0.0.0	M835 Inputs
M835 Outputs	Deep Sea Electronics	1.0.0.0	M835 Outputs

Callouts provide the following instructions:

- Right-Click Device...
- And select Add Device.
- Select Deep Sea Electronics
- Select the device to add...
- And click Add Device.
- Add other devices if required, then click Close when finished.

4.7 BUTTONS

4.7.1 BUTTON LOCATION

The below image shows the location of the buttons along with their default names within the CODESYS environment.

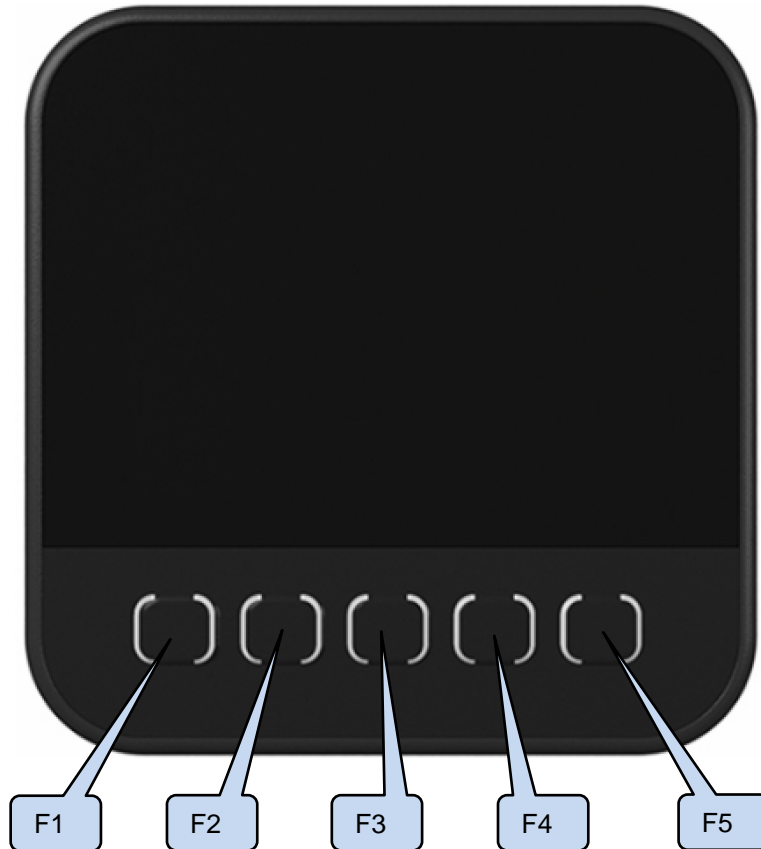

4.7.2 BUTTON SETTINGS

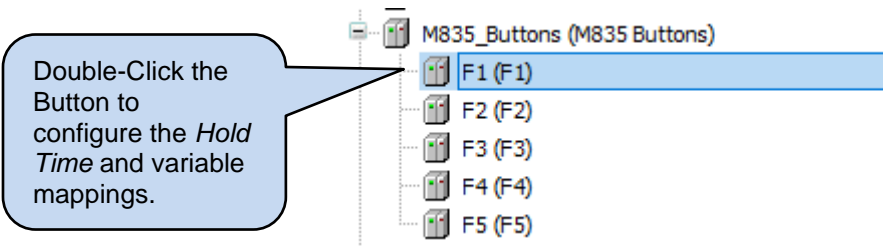

4.7.2.1 PARAMETERS

Parameter	Description
Hold Threshold	Amount of time (in milliseconds) that the button must be pressed before it is considered 'held down'.

4.7.2.2 I/O MAPPING

Parameter	Description
State	Indicates if the button is pressed (TRUE) or not pressed (FALSE).
Held	Indicates if the button has been held for longer than the duration of the <i>Hold Threshold</i> (TRUE) or not (FALSE).
Hold Time	The amount of time (in milliseconds) that the button has been pressed for (zero if not currently pressed).

4.8 INPUTS

To select between the different input types (digital or analogue), we must *Plug* a device into the input slot.

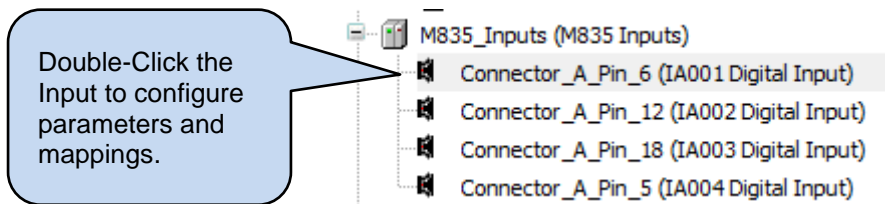
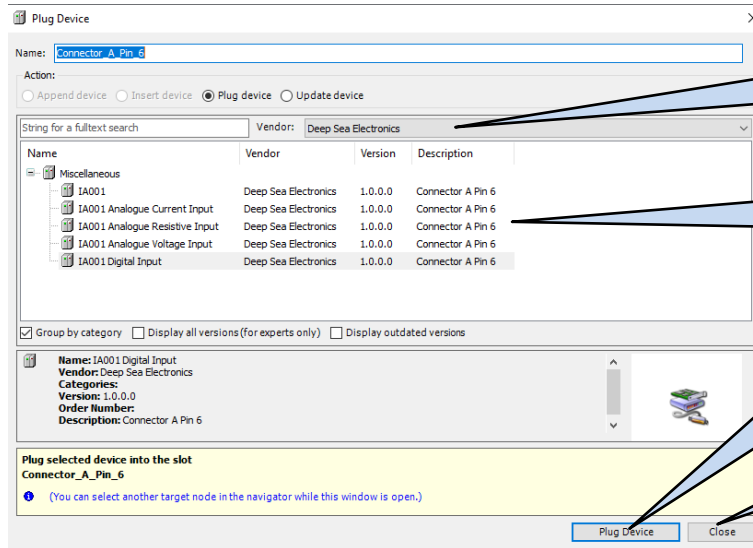
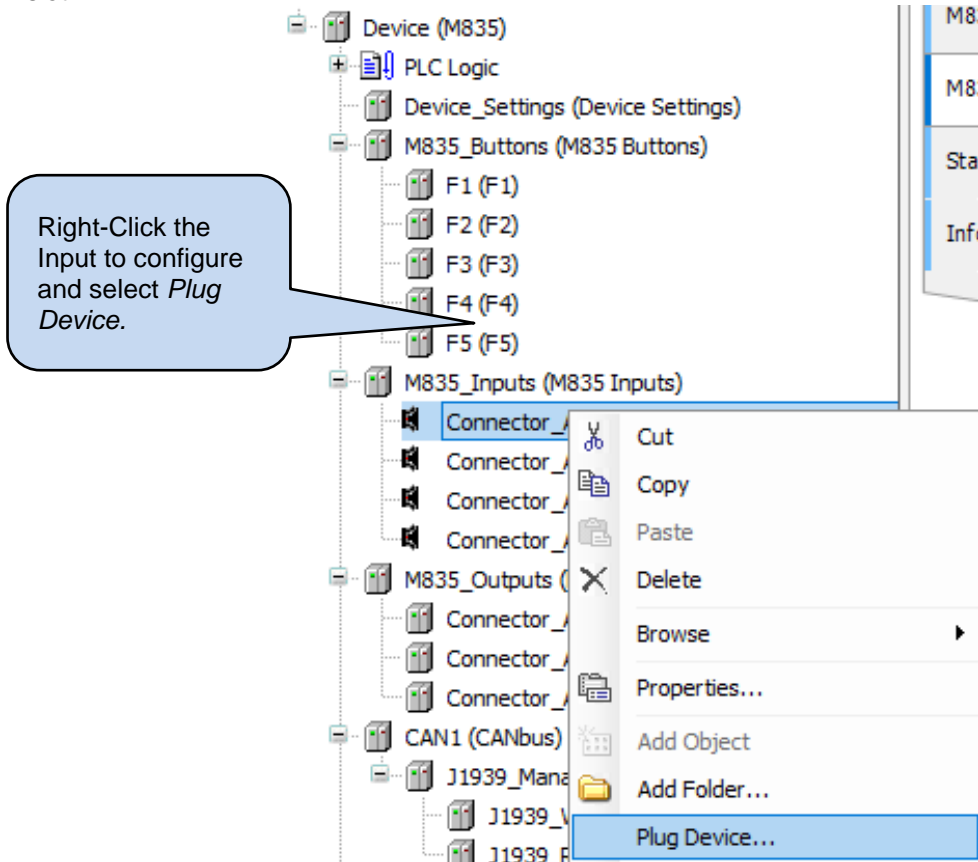

4.8.1 DIGITAL INPUTS

4.8.1.1 PARAMETERS

Parameter	Description
Resistor	<p>Float: The input is floating when no connection is made. Used where the external sensor (NPN Sinking or PNP Sourcing type) has an integrated pull-up or pull-down resistor.</p> <p>Pull Up: An internal pull up resistor biases the input to the positive supply rail when no connection is made. Commonly used with NPN (Sinking) type switched sensors and volt-free contacts.</p> <p>Pull Down: An internal pull-down resistor biases the input to the negative supply rail when no connection is made. Commonly used with PNP (Sourcing) type switched sensors and volt-free contacts.</p>
Higher Threshold	The input is detected as being inactive when above this threshold with respect to the negative supply rail.
Lower Threshold	The input is detected as being active when below this threshold with respect to the negative supply rail.

4.8.2 ANALOGUE INPUTS

4.8.2.1 CURRENT

Parameter	Description
Current Range	<p>0..20 mA: The input is 0 mA to 20 mA.</p> <p>4..20 mA: The input is 4 mA to 20 mA.</p>

I/O Mapping	Description
Value	The current value of the input (μA , microamps) is mapped to the selected program variable.
Error Code	The current error state of the input is mapped to the selected program variable.

4.8.2.2 RESISTIVE

I/O Mapping	Description
Value	The current value of the input (Ω) is mapped to the selected program variable.
Error Code	The current error state of the input is mapped to the selected program variable.

4.8.2.3 VOLTAGE

I/O Mapping	Description
Value	The current value of the input (mV, milli Volts) is mapped to the selected program variable.
Error Code	The current error state of the input is mapped to the selected program variable.

4.9 OUTPUTS

I/O Mapping	Description
Enable	FALSE: The output is inactive. TRUE: The output is active.

4.10 USING THE DISPLAY IN THE PROJECT (VISUALISATION)

CODESYS 3.5 includes the facility to design and manipulate the LCD of the device. While the operation of the CODESYS environment is detailed within the CODESYS online document, this section provides a quick-start guide to using the *Visualisation* component of CODESYS 3.5. DSEM835 visualisation options differ with some of DSE's other displays as it uses *TargetVisuLight* (CODESYS TVL) Library to economise resources.

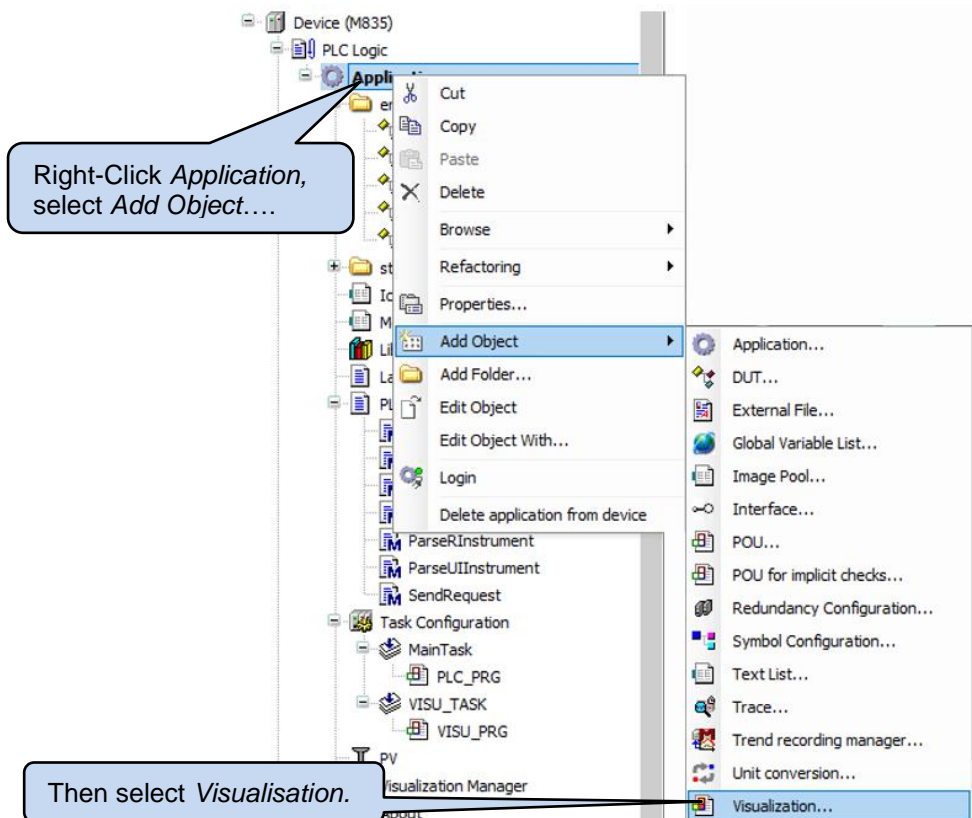

4.10.1 VISUALISATION ELEMENTS

The following Visualisation Elements are available for DSEM835. Select the element required and place them in the Visualisation.



The following subsections provides insights as to how to meet most common requirements of a device Visualisation.

Advice regarding the suggested solutions is available from support@deepseaelectronics.com.

4.10.2 TEXT (FIXED OR DYNAMIC)

NOTE: Text *Fonts* occupy a large amount of system memory. To save resources, ensure to follow the instructions in the subsection entitled *Using Fonts*.

Use the flexible *Rectangle* element which provides the functionality of a rectangle (with optional border and fill), and an integral Text Field that may be fixed, or programmatically altered using the Text Variable property.

Border and Fill settings are disabled by setting the *Fill Attributes* and *Line Style* properties to *Hollow*.

Property	Value
Text ID	1644
Type of element	Rectangle
+ Position	
+ Center	
+ Colors	
- Element look	
Line width	1
Fill attributes	Hollow
Line style	Hollow
+ Texts	
+ Text properties	
+ Absolute movement	
+ Relative movement	
+ Text variables	
+ Font variables	
+ Color variables	
- State variables	
Invisible	

Use the *Rectangle* element.

Set to *Hollow* to disable these items if required.

4.10.2.1 TEXT SIZE

When selecting Text (font) size, only *Integer* font sizes are possible. Where other sizes are mistakenly used, the font appears on the M835 display in a default (small sized) font.

CODESYS allows selection of font sizes that are not appropriate for DSEM835. For example, it is

possible to select Arial 7. After closing the font selector, it appears correctly set as Arial; 7 in the *Property window*. However, when selecting it with the mouse, the font size is actually not an integer:

Arial, 6.75pt. The font selector and property window ‘round up’ the font size until selected with the mouse.





To minimise occurrences of this error it is recommended to select Text Size from the following options (all multiples of 3: 6, 9, 12, 15, 18, 21, 24... etc).

4.10.2.2 TEXT COLOUR

Fixed Colour

Within *Colors* select the colour required for the *Normal* and *Alarm* state. *Alarm* state is used when *Color Variable | Toggle Color* is *TRUE*. Note that a setting in *Color Variables* overrides this selection.

Within *Text Properties* select the colour required for the text. Note that a setting in *Font Variables* overrides this selection.

Property	Value
Text ID	1644
Type of element	Rectangle
+ Position	
+ Center	
- Colors	
- Normal state	
Frame color	 Baseelementframecolor
Fill color	 Baseelementfillcolor
- Alarmstate	
Frame color	 Baseelementalarmframecolor
Fill color	 Baseelementalarmfillcolor
+ Element look	
+ Texts	
- Text properties	
Horizontal alignment	Left
Vertical alignment	Centered
Font	Arial; 9
Font color	 Fontcolor

Programmatically Change Colour

If required to change the text colour during application runtime, *Font Variables* is used as follows:

Within *Font Variables* select the variable containing the colour required for the element.

- Font variables	
Flags	
Color	PLC_PRG.ColourWhite

Colour is defined as a DINT variable containing the RGB values for the colour (ie 16#RRGGBB)

Example to define the colours :

```

ColourWhite      :      DINT:=16#FFFFFF;
ColourBlack     :      DINT:=16#000000;
ColourRed       :      DINT:=16#FF0000;
ColourGreen     :      DINT:=16#00FF00;
ColourBlue      :      DINT:=16#0000FF;
    
```

Text colour in the PC Visualisation Editor remains as the colour selected in *Text Properties*.

4.10.2.3 STRING ESCAPE CHARACTER \$

Strings can include 'special' characters as well as the common alphanumeric characters. For example, a string can include the single quote (') character. However, this character is used as the STRING start and end. Therefore, a special character known as the escape character is used to inform CODESYS that the ' character should be displayed and not considered as a string start/end. This character is the dollar sign (\$).

In the event we need to display a dollar sign we again prefix it with the escape character (\$). While the CODESYS inbuilt help file contains a comprehensive list of escape codes, the following details the most common.

String	Displayed as
'	'
\$\$	\$
\$t or ST	Control Character TAB

Examples:



```
VAR
    MyString    :    STRING:='This $'fee$' is $$50';
END_VAR
```

The string contains the message: **This 'fee' is \$50**

4.10.2.4 USING FONTS

NOTE: If the *Font Settings* tab is not visible within the Visualization Manager, close the tab, then again double click Visualization Manager to open it again and view the settings.

Text fonts are resource hungry. They occupy large parts of the system memory. To make efficient use of the memory, CODESYS allows us to choose how the font is sent to the device:

Double Click  Visualization Manager in the project tree and select the  Font settings tab:

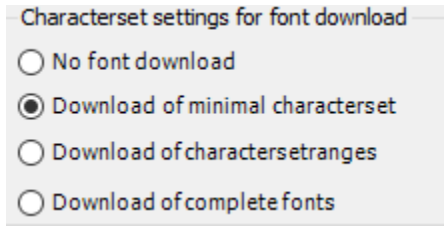

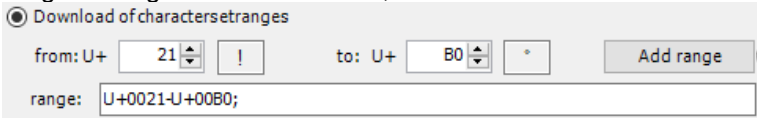
Parameter	Description																																																																																																																								
Character Settings for Font Download	<p>No Font Download: (Not Recommended) No font is sent to the device.</p> <p>Download of Minimal Character Set: (Recommended). All characters used in the visualisation are downloaded to the device. However, any characters not used in the visualisation but used in variables (ie Strings) are NOT sent to the device. To 'force' characters to be sent to the device:</p> <ul style="list-style-type: none"> • Use a hidden visualisation page containing all the font/character selection required for the application. • Use <i>Download of Character Set Ranges</i>. <p>Download of Character Set Ranges: (Advanced). The user selects which character range or ranges to send to the device. Windows Character Map is a useful tool for identifying the range(s) of characters you may need.</p> <p>Adding the range <i>U+0021-U+00B0</i>;</p>  <p>ensures that most used characters are sent to the device (a to z, A to Z, 0 to 9 and many punctuation characters):</p> <table border="1" style="width: 100%; text-align: center; font-family: monospace;"> <tr><td>!</td><td>"</td><td>#</td><td>\$</td><td>%</td><td>&</td><td>'</td><td>(</td><td>)</td><td>*</td><td>+</td><td>,</td><td>-</td><td>.</td><td>/</td><td>0</td><td>1</td><td>2</td><td>3</td><td>4</td></tr> <tr><td>5</td><td>6</td><td>7</td><td>8</td><td>9</td><td>:</td><td>;</td><td><</td><td>=</td><td>></td><td>?</td><td>@</td><td>A</td><td>B</td><td>C</td><td>D</td><td>E</td><td>F</td><td>G</td><td>H</td></tr> <tr><td>I</td><td>J</td><td>K</td><td>L</td><td>M</td><td>N</td><td>O</td><td>P</td><td>Q</td><td>R</td><td>S</td><td>T</td><td>U</td><td>V</td><td>W</td><td>X</td><td>Y</td><td>Z</td><td>[</td><td>\</td></tr> <tr><td>]</td><td>^</td><td>_</td><td>`</td><td>a</td><td>b</td><td>c</td><td>d</td><td>e</td><td>f</td><td>g</td><td>h</td><td>i</td><td>j</td><td>k</td><td>l</td><td>m</td><td>n</td><td>o</td><td>p</td></tr> <tr><td>q</td><td>r</td><td>s</td><td>t</td><td>u</td><td>v</td><td>w</td><td>x</td><td>y</td><td>z</td><td>{</td><td> </td><td>}</td><td>~</td><td>ı</td><td>¢</td><td>£</td><td>¤</td><td>¥</td><td></td></tr> <tr><td>ı</td><td>§</td><td>¨</td><td>©</td><td>ª</td><td>«</td><td>¬</td><td>-</td><td>®</td><td>¯</td><td>°</td><td></td><td></td><td></td><td></td><td></td><td></td><td></td><td></td><td></td></tr> </table> <p>Download of Complete Fonts: (Not Recommended). The complete character set of all used fonts is sent to the device occupying a large amount of memory in the device.</p>	!	"	#	\$	%	&	'	()	*	+	,	-	.	/	0	1	2	3	4	5	6	7	8	9	:	;	<	=	>	?	@	A	B	C	D	E	F	G	H	I	J	K	L	M	N	O	P	Q	R	S	T	U	V	W	X	Y	Z	[\]	^	_	`	a	b	c	d	e	f	g	h	i	j	k	l	m	n	o	p	q	r	s	t	u	v	w	x	y	z	{		}	~	ı	¢	£	¤	¥		ı	§	¨	©	ª	«	¬	-	®	¯	°									
!	"	#	\$	%	&	'	()	*	+	,	-	.	/	0	1	2	3	4																																																																																																						
5	6	7	8	9	:	;	<	=	>	?	@	A	B	C	D	E	F	G	H																																																																																																						
I	J	K	L	M	N	O	P	Q	R	S	T	U	V	W	X	Y	Z	[\																																																																																																						
]	^	_	`	a	b	c	d	e	f	g	h	i	j	k	l	m	n	o	p																																																																																																						
q	r	s	t	u	v	w	x	y	z	{		}	~	ı	¢	£	¤	¥																																																																																																							
ı	§	¨	©	ª	«	¬	-	®	¯	°																																																																																																															

4.10.3 LINE CHART

The *Polyline* element can be added, using *Dynamic Points* to allow the line to be manipulated using an array of points

Use the *Polyline* element.

Property	Value
Type of element	Polyline
[-] Position	
[+] Points	
[+] Center	
[-] Element look	
Line width	1
Fill attributes	Filled
Line style	Solid
[+] Texts	
[+] Text properties	
[+] Absolute movement	
[-] Dynamic points	
Array of points	PLC_PRG.ChartPoints
Number of points	10

Map the array of points containing the coordinates of the line points.

4.10.4 LAMP OR LED

Use the *Ellipse* element to add a circular shape. Use either the *Color* property to change the fill colour or use the *Toggle Color* property to select between the *Normal State* and *Alarm State* colour configurations.

Property	Value
Type of element	Ellipse
[-] Position	
X	272
Y	64
Width	25
Height	25
[+] Center	
[+] Element look	
[+] Texts	
[+] Text properties	
[+] Absolute movement	
[+] Relative movement	
[-] Text variables	
Text variable	
[+] Font variables	
[-] Color variables	
Toggle color	PLC_PRG.LED1
[-] Normal state	
Frame color	PLC_PRG.Black
Fill color	PLC_PRG.DarkGrey
[-] Alarmstate	
Frame color	PLC_PRG.Black
Fill color	PLC_PRG.Red

Use the *Ellipse* element.

Map a BOOL used to change the state of the LED/Lamp indicator. This selects between *Normal* and *Alarm State*.

Map to the variables that define which colours to use (RGB colour)
ie
Red : DWORD:= 16#FF0000

4.10.5 ALTERNATIVE TO TEXTLISTS

CODESYS TargetVisuLight does not include support for TextLists provided in devices with the full CODESYS VisuElems library. However, some functions are still available utilising alternative methods.

4.10.5.1 DYNAMIC TEXT

Dynamic Text is using a Visualisation element to display text that changes depending upon some condition within the application. For example, this could be indication the position of a control switch. Alternative methods exist, this being the recommended option having the advantage of the text being easily located at the top of the POU in the VAR area.

In this example iSwitchPosition is the physical position of the switch. We use this to index into an array to show the position in text, rather than a number.

```
VAR
    asSwitchPosition    :ARRAY[0..3] of STRING:=['Off', 'Manual', 'Auto', 'Test'];
    iSwitchPosition     :INT:=0;
END_VAR
```

Then in the Visu, we add the following :

The screenshot shows the configuration for a dynamic text element in the Visualisation editor. The 'Text' field is set to '%s'. The 'Text variable' field is set to 'PLC_PRG.asSwitchPosition[iSwitchPosition]'. Two callout boxes provide explanations:

- One callout points to the '%s' in the text field, stating: "%s as a placeholder for the text."
- Another callout points to the array indexing in the text variable field, stating: "Point to the array, with the individual element selected by the variable within [..]"

4.10.6 USING CUSTOM IMAGES ON THE DISPLAY

Many applications require custom images to be placed on the DSEM835 display. This is controlled using an *Image Pool* within CODESYS. The Image Pool acts as a container for the images, which are then selected for display.

4.10.6.1 ADDING AN IMAGE POOL

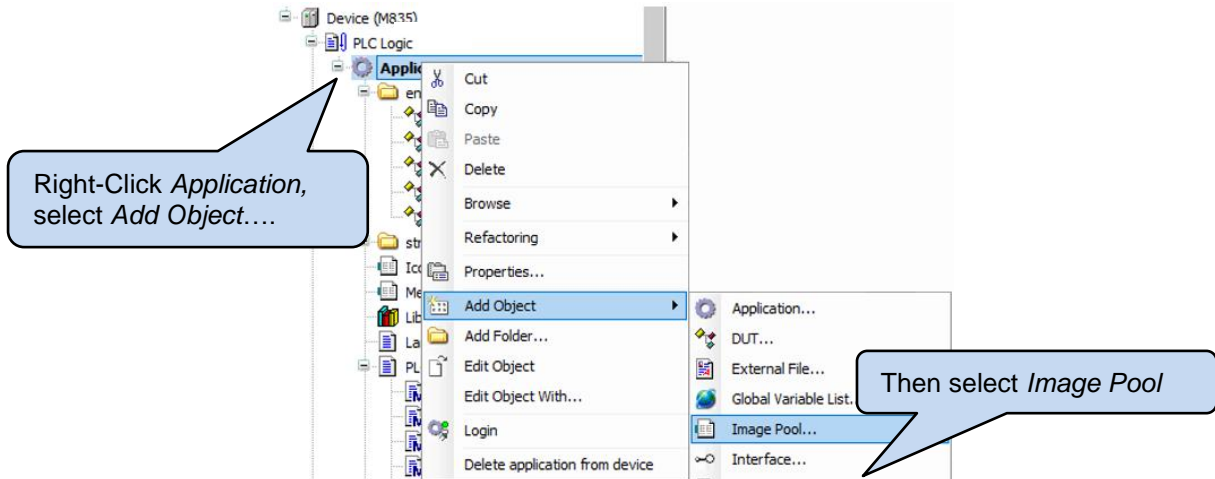

4.10.6.2 ADDING IMAGES TO THE IMAGE POOL

NOTE: Images must be Windows Bitmap (.bmp) type with 8-bit, 16-bit or 24-bit colour depth. Other image types are not supported.

NOTE: Images **MUST** be scaled externally before being imported to the image pool.

NOTE: For image transparency see section entitled *Device Settings | Transparency*.

NOTE: Multiple Image Pools may be used to keep images of similar type or usage together.

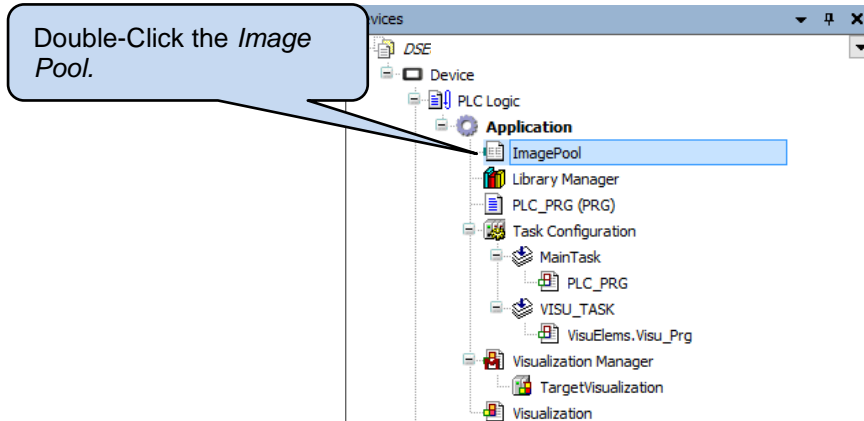

Connecting to CODESYS

Right-Click the empty line and select *Insert Image*.

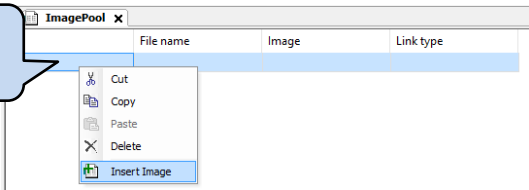

Then Double-Click the empty space under *File name* and click ...

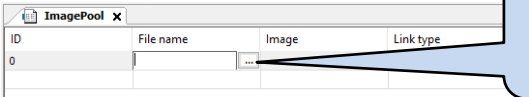

Browse to the image on your computer...

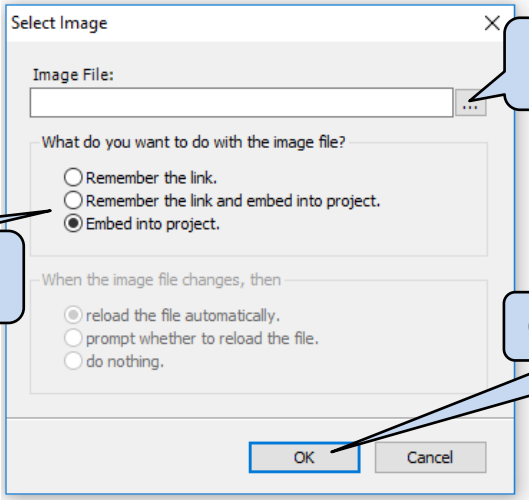

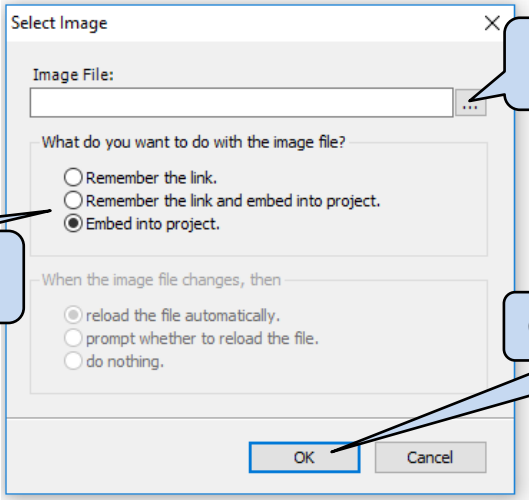

And select how the image is stored in the project.

Click OK when done.

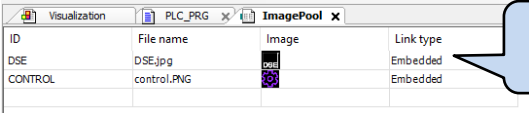

Example entries in the *Image Pool*.



ID	File name	Image	Link type
DSE	DSE.jpg		Embedded
CONTROL	control.PNG		Embedded

4.10.6.3 USING THE IMAGE POOL ON THE DISPLAY

Entries within the Image Pool are automatically detected by the CODESYS Visualisation Toolbox and are available for placing on the Visualisation.

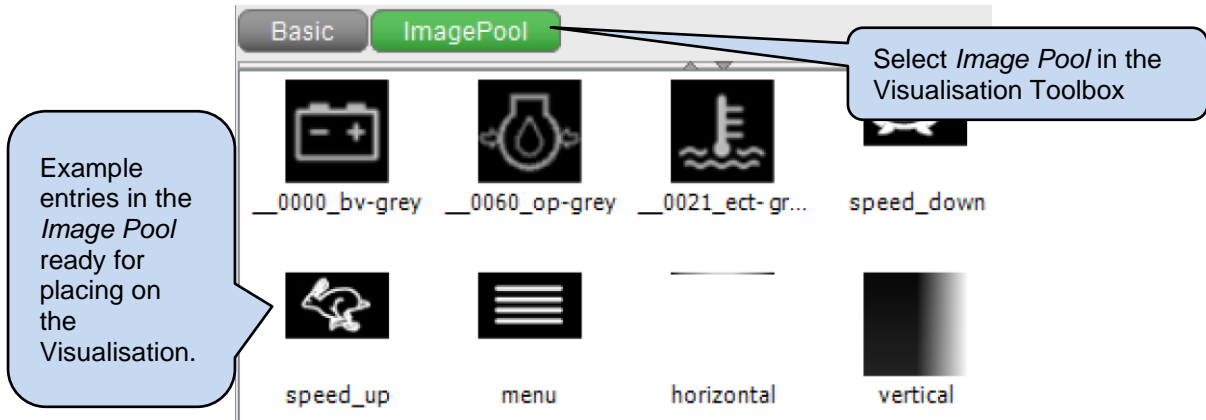

You MUST select *Scaling Type: FIXED*.
Scaling within CODESYS is not supported.
After pressing *ENTER* this property is no longer displayed.

Property	Value
Type of ele...	Image
Static ID	ImagePool.HOME
Show frame	<input type="checkbox"/>
Scaling type	Fixed

4.10.6.4 GRAPHICAL GAUGES OR IMAGE SWITCHING

Multiple Images

Multiple images may be used to provide animation. This method has a number of images, each one different to the others. Swapping between images gives the illusion of animation.

Use the Image Pool to load in the required images. Add an *Image* to the visualisation and change the image reference using the *DynamicBitmap* property.

Use the *Image* element.

Property	Value
Type of element	Image
Static ID	MeterImages.M835_Large_1
Show frame	
+ Position	
+ Center	
+ Element look	
+ Texts	
+ Text properties	
- Bitmap ID variable	
Bitmap ID	PLC_PRG.EngineSpeed.MeterImage.Large

Map a STRING that matches the *ID* of an image within the image pool. The POU code should select the image based upon the value that is to be displayed.

Element Rotation

NOTE: *Interior Rotation* is available only with the *Polyline* Visualisation element.

Visualisation Element *Polyline* may be rotated at application runtime. For example, this technique can be used to give motion to a meter needle, or to show a valve opening/closing.

Select the variable containing the angle of rotation and map to the *Interior rotation* property.

- Absolute movement	
- Movement	
X	
Y	
Rotation	
Scaling	
Interior rotation	PLC_PRG.Angle

4.11 CAN

 **NOTE:** To program the device using CAN, see section entitled *Cables, Connectors, Harnesses and Spare Parts* for details of a suitable PC USB CAN interface.

 **NOTE:** DSE_CAN compiled library, supplied as part of the DSE CODESYS Package available from www.deepseaelectronics.com.

DSEM835 CAN interface is used to configure the device (using CODESYS) and to connect to external CAN devices such as engine ECUs and DSEM240 (Input/Output expansion).

CAN Protocol	Options
SAE J1939	<ul style="list-style-type: none"> • CODESYS J1939 (see section entitled <i>CODESYS J1939</i>) • DSE_CAN compiled library
Raw CAN (custom protocols)	<ul style="list-style-type: none"> • DSE_CAN compiled library
Other CAN protocols	Contact support@deepseaelectronics.com

4.11.1 DSE_CAN

DSE_CAN compiled library, supplied as part of the *DSE CODESYS Package* available from www.deepseaelectronics.com allows standard CAN messages to be sent and received. This may be used (with customer application code) to interface with J1939, custom protocols and other CAN protocols as required.

Contact support@deepseaelectronics.com for advice on the DSE_CAN compiled library.

4.11.2 CODESYS J1939

NOTE: CODESYS CAN devices are not required within the project unless attaching a J1939 CAN Manager to it.

CODESYS J1939 is a complete J1939 implementation for sending and receiving J1939 CAN messages. Conversion to/from actual values and CAN data is automatic (when enabled).

First add the CAN device to the project:

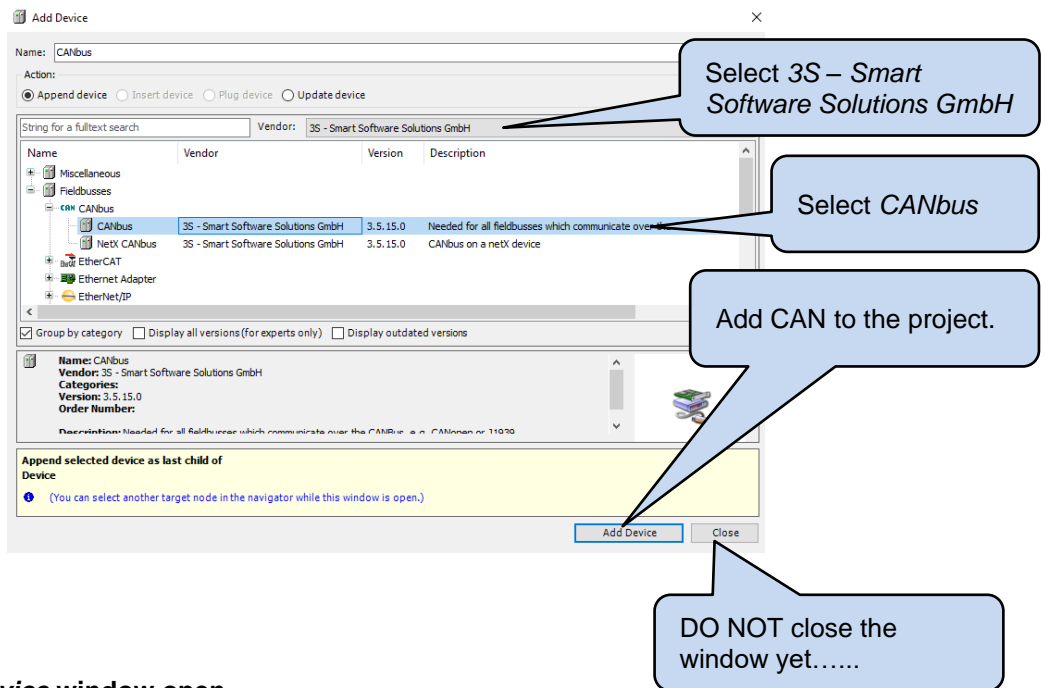
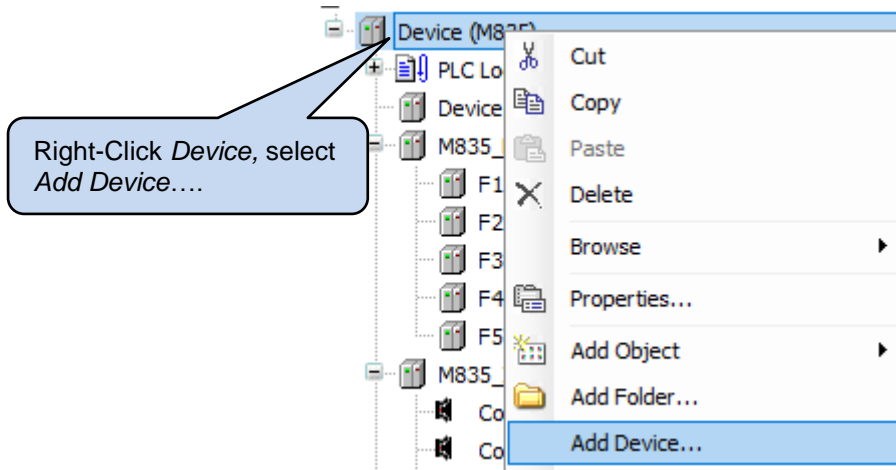

Keep the *Add Device* window open.

Connecting to CODESYS

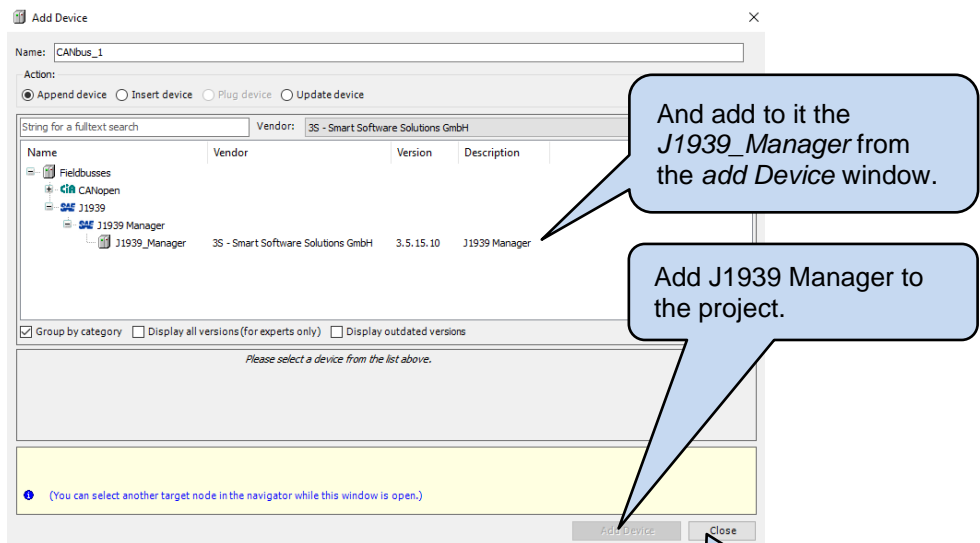
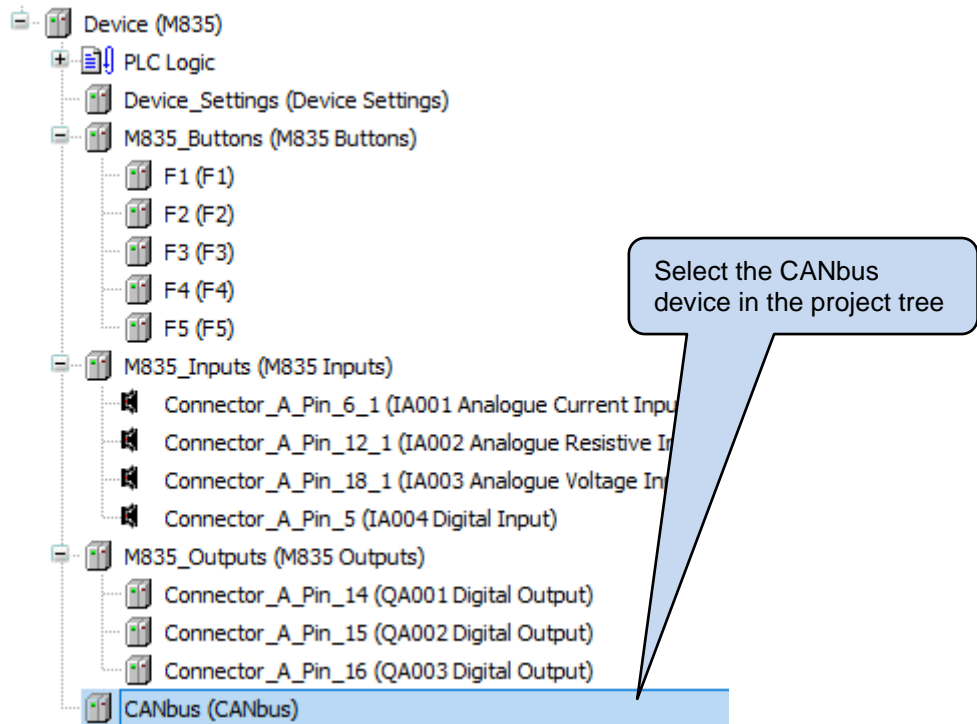

Keep the Add Device window open.

DO NOT close the window yet.....

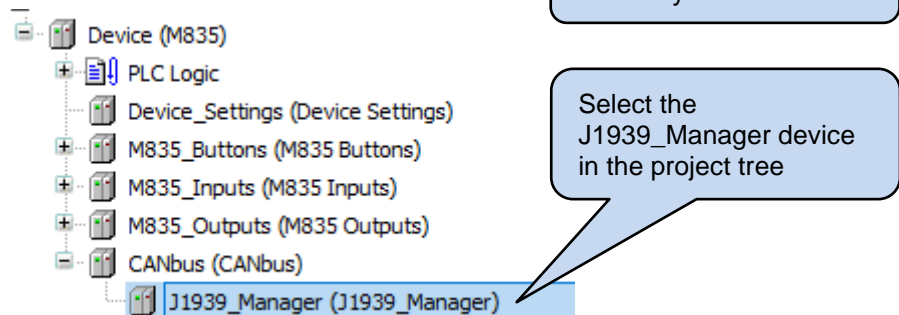

Connecting to CODESYS

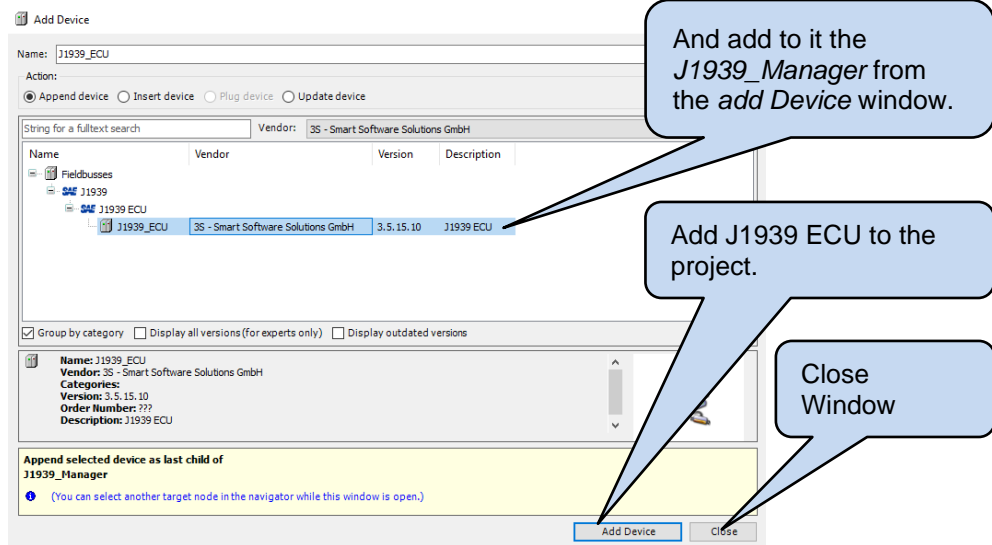

The project is now able to communicate with one J1939 ECU. Other devices may be added as required to allow communication with other J1939 ECUs on the same CAN.

For further information, please contact support@deepseaelectronics.com.

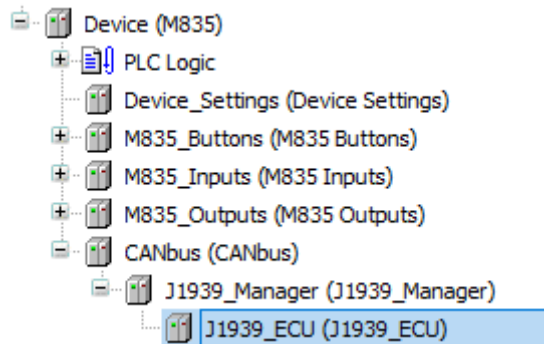

5 DSEM835 CODESYS ERROR CODES

DSEM835 returns error codes to CODESYS when appropriate. Individual bits are set within the returned value to indicate one or more error conditions. This can be mapped to a variable if required and is available to view within CODESYS under the *Device Settings I/O Mapping*.

Example:

A *Device* error value of 2 (00000010 in binary) indicates *Over Temperature*.

5.1 DEVICE

MSB	Bit						LSB
8	7	6	5	4	3	2	1
Output Reference Outside Limits	Reserved	Reserved	Reserved	Reserved	Under Voltage Supply	Over Temperature	Error

5.2 DIGITAL INPUTS

Input Configuration	MSB	Bit						LSB
	8	7	6	5	4	3	2	1
Digital	Invalid Parameter	Reserved	Reserved	Reserved	Reserved	Reserved	Reserved	Error
Frequency	Invalid Parameter	Reserved	Reserved	Reserved	Reserved	Freq Over Range	Reserved	Error

5.3 DIGITAL OUTPUTS

Output Configuration	MSB	Bit						LSB
	8	7	6	5	4	3	2	1
Digital	Invalid Parameter	Reserved	Reserved	Reserved	Reserved	Reserved	Reserved	Error

6 CABLES, CONNECTORS, HARNESSES AND SPARE PARTS

Description	DSE Part	Manufacturer Part	Manufacturer
DSEM835 Connector A	007-850	DT16-18SA-K004	TE / Deutsch
Connector Pin Crimp (0.5 mm ² to 1.0 mm ²)	N/A	0462-201-16	TE
Connector Pin Crimp (2 mm ²)		0462-209-16	TE
DSEM835 Connector Harness Kit	016-176	N/A	DSE
DSEM835 Connector Configuration Harness.	016-177	N/A	DSE
Pin Blank Inserts (Seals unused connector pins)	N/A	114017	TE
Belden 9841 (CAN Cable)	016-030	9841	Belden
PCAN-USB PC Configuration Interface	016-179	IPEH-002021 or IPEH-002022	PEAK-System Technik GmbH
Rear Case Ring Nut	020-1058-01	N/A	DSE

6.1 DSEM835 CONNECTOR HARNESS (016-176)

DSE Part 016-176 consists of a cable with connector fitted at one end, with cable marking to identify the wires at the other end.

Connector A	
Assembly Ident	007-850
AMP Connector	DT16-18SA-K004
No of Connections	18
Wire size	0.5 mm ² (AWG 20)
Wire Colour	Black
Wire Idents	1 to 18
Connector Pin Crimp (0.5 mm ² to 1.0 mm ²)	0462-201-16
Connector Pin Crimp (2 mm ²)	0462-209-16

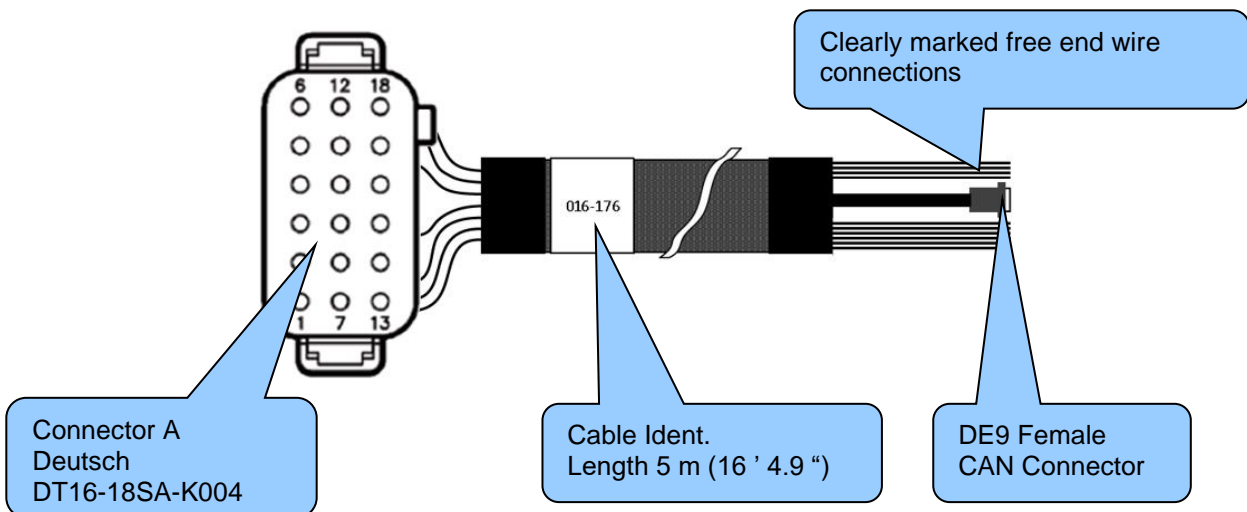

6.2 DSEM835 CONFIGURATION HARNESS (016-177)

NOTE: DSEM835 Configuration Harness 016-177 must be used in conjunction with Peak Systems USB CAN interface IPEH-002021 or IPEH-002022 from <https://www.peak-system.com>

DSE Part 016-177 consists of a minimal cable with connector fitted at one end with DC supply wires and DE9 CAN connector at the other end. This is designed to connect to the DE9 connector of the USB CAN interface.

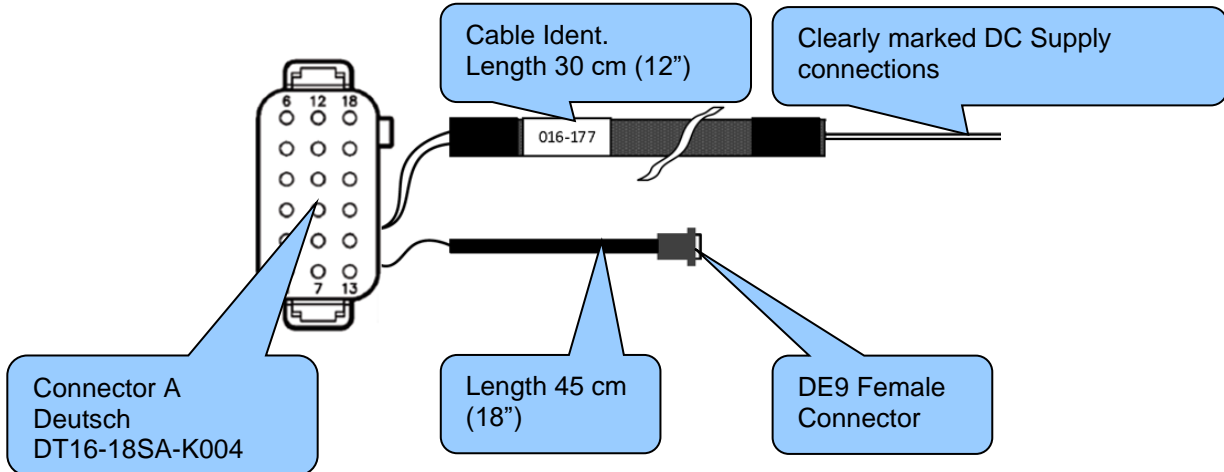

Description	Connector A	Termination
DC Positive	7	Single wire
DC Negative	1	Single wire
CAN SCR	2	DE9 Pin 5
CAN L	3	DE9 Pin 2
CAN H	4	DE9 Pin 7

6.3 PCAN-USB CONNECTION DETAILS

NOTE: Where a DSE Configuration or Connection Harness is not used, connection details for PCAN-USB are shown below. PCAN-USB supplier details are given in the section entitled *Maintenance Spares, Repair and Servicing* elsewhere in this document.

NOTE: DSE Stock and supply PCAN-USB IPEH-002021. DSE Part number 016-179. Contact sales@deepseaelectronics.com.

Connect PCAN-USB to DSEM835 using connections for CAN H, CAN L and GND. For suitable connection looms from DSE, see sections entitled *DSEM835 Connector Harness* and *DSEM835 Configuration Harness*.

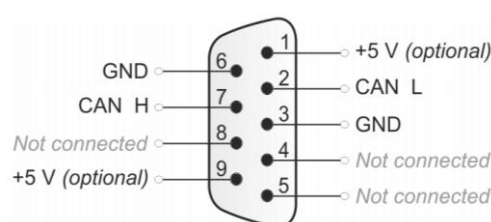

Shown looking at the PCAN-USB interface from the 'outside'

7 MAINTENANCE AND WARRANTY

The device is *Fit and Forget*. As such, there are no user serviceable parts within the controller. In the case of malfunction, you should contact your original equipment manufacturer (OEM).

DSE Provides limited warranty to the equipment purchaser at the point of sale. For full details of any applicable warranty, refer to the original equipment supplier (OEM).

8 DISPOSAL

8.1 WEEE (WASTE ELECTRICAL AND ELECTRONIC EQUIPMENT)

If you use electrical and electronic equipment you must store, collect, treat, recycle and dispose of WEEE separately from your other waste



This Page is Intentionally Blank